



# BONITRON

*Solutions for AC Drives*



2024

## PRODUCT OVERVIEW

# Bonitron Solutions for AC Drives

Industrial electronics have evolved greatly over the half-century that Bonitron has been in business, but one thing remains constant; Users want their drive systems and processes to be reliable and maximize productivity.

Bonitron specializes in designing accessories for variable speed drives and offers solutions ranging from Overvoltage braking solutions, such as Braking Transistors, Resistors, and Line Regeneration, to Undervoltage Solutions, such as UPD Uninterruptible Power for Drives. Other solutions include Single and 3-Phase Power Supplies, as well as Portable Capacitor Formers.

With thousands of engineered products and new solutions released regularly, visit [Bonitron.com](http://Bonitron.com) or contact your local drive distributor to learn more.

As always, 'if you have VFDs, you'll need some of these!'

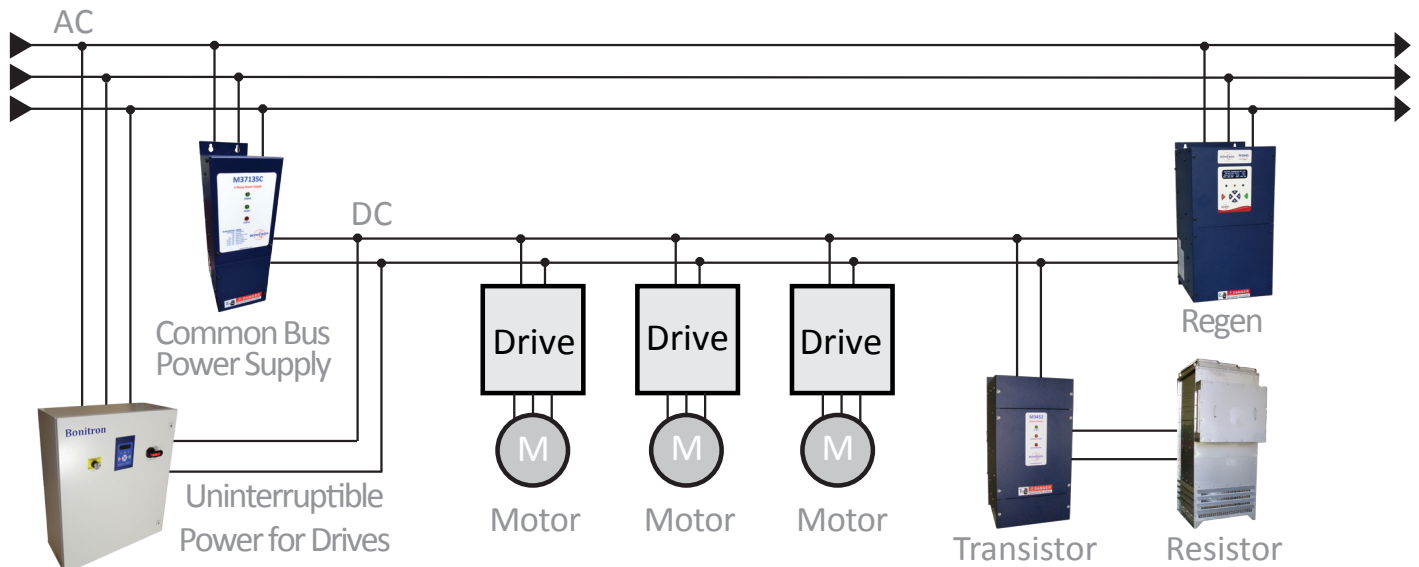
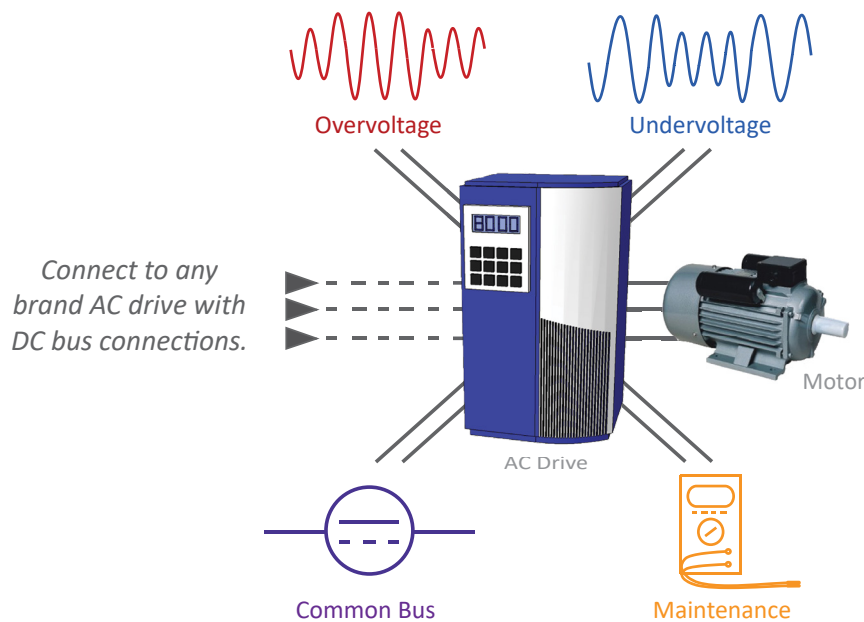

# TABLE OF CONTENTS

**Line Regeneration**

- M3545 & M3645.....3 - 4

**Braking Transistors**

- M3452.....5 - 8
- M3675T & M3575T.....9

**Braking Resistors**

- CaseResistors.....10
- M3775R.....11
- M3575R.....12
- M3452 Complete.....14

**Servo Motor Braking**

- M3500DB.....15



**UPD Ride-Thru Systems.....18 - 19**

**Voltage Regulators**

- M3460R.....20
- M3460B.....21

**Energy Storage**

- M5628 .....22
- M3528 .....23
- M3528B.....24

**Dischargers**

- KIT3628.....25

**Digital Display**

- KIT3660DD5.....26



**Common Bus Sharing Diodes**

- M3345CBM.....29

**Regenerative DC Bus Power Supply**

- M3545P & M3645P.....30

**Bus Filter Capacitance**

- M3612EC & M361RC .....31

**Single Phase Power Supplies**

- M3712.....33

**3-Phase Power Supplies**

- M3713.....34 - 35

**24VDC Power Supplies**

- M7009.....36

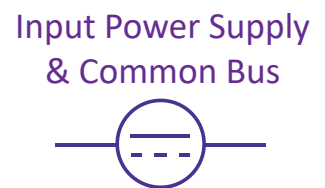

**Portable Capacitor Former**

- M3628PCF.....38

**Automatic Capacitor Former & Ultracapacitor Discharger**

- M362ACF & M3628PUD.....39

**Ultracapacitor Tester's**

- M3528UCT & M3628UMT.....40

**Regen Energy Monitor**

- M3660REM.....41



# Custom Solutions

Not only does Bonitron have standard products, but we are able to solve specific solutions for custom applications and projects.

*"If you don't see what you need, call us and we'll work together to create a solution to fit your needs!"*

*- Keith Benson*



## Power Supply

- Low-Voltage Power Supply used for a streetcar/Trolley project
- Isolated 28V 250-amp battery charger
  - 700-1000VDC input to car from cantenary
- Boost from 24V battery string to operate drives during outage
- Relatively low power of 7kW



## 3-phase Power Supply

- Replacement Power Supply for amusement park
- 230VAC three-phase input
- 100ADC output
- Integrated braking transistor



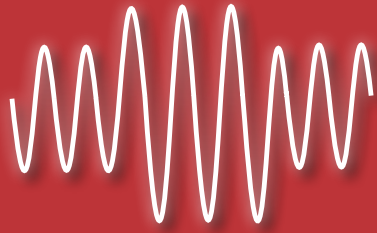

## *Overvoltage Solutions*

### **Line Regeneration**

- M3545
- M3645

### **Braking Transistors**

- M3452
- M3675T
- M3575T

### **Braking Resistors**

- Case Resistors
- M3775RPF
- M3575R
- M3775R

### **Combo Units**

- M3452 Complete

### **Servo Motor Braking**

- M3500DB





# Understanding Braking Conditions

## Overhauling

An overhauling load requires braking to keep the motor from increasing speed beyond the speed set by the drive. The required braking torque remains constant and approximately twice the power of deceleration braking is required.

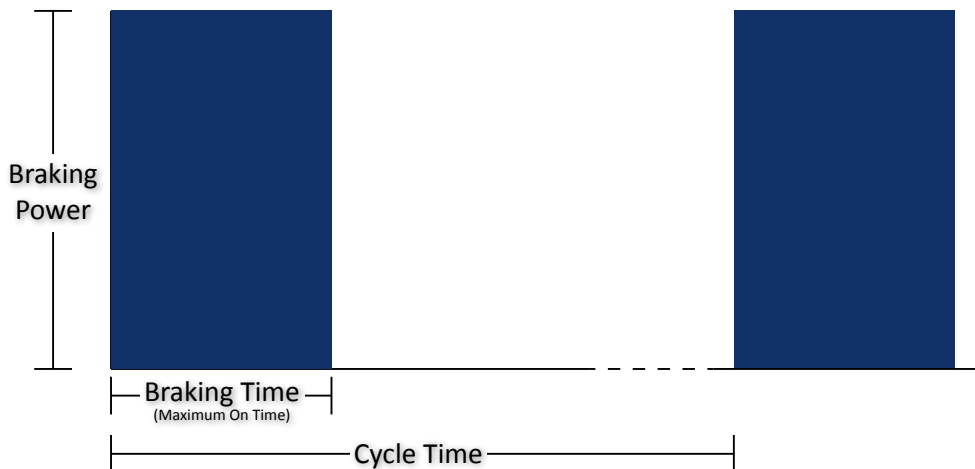

$$\text{Overhauling Duty} = \frac{\text{Braking Time}}{\text{Cycle Time}}$$

## Deceleration

During deceleration, braking is required to stop or reduce the speed of the motor. The required braking torque reduces with speed and approximately half the power of braking an overhauling load is required.

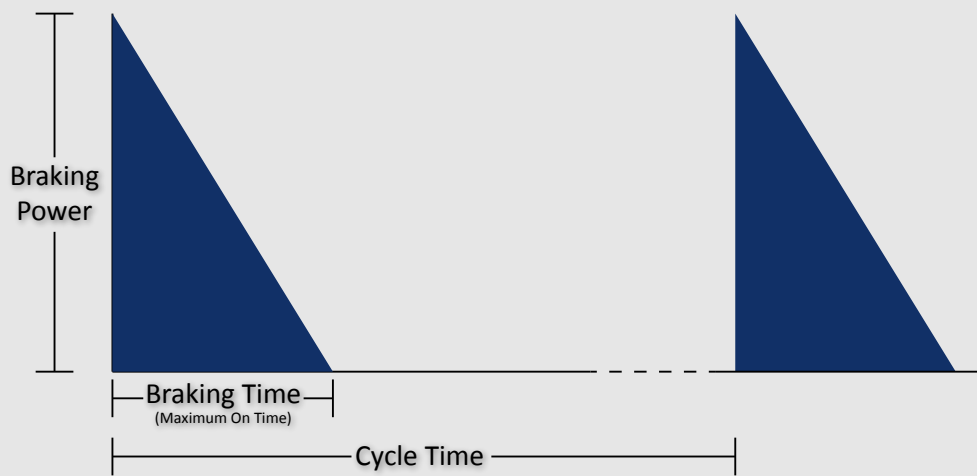

$$\text{Deceleration Duty} = \frac{\text{Braking Time}}{\text{Cycle Time}}$$



# Line Regeneration

M3545 & M3645

## Overvoltage Solutions



**M3645 Series**



**M3545 Series**

Bonitron Line Regens replace traditional braking transistor and resistor options that waste energy as heat during drive braking. Instead of dissipating braking energy as heat in a resistor, Line Regen solutions return this energy to the power grid. This reduces demand from the utility, which equates to ample energy savings.

The Bonitron Line Regen is efficient and small enough to be integrated into the drive cabinet. This eliminates excess resistor wiring and cooling costs.



Display & Indicators	LED Indicators			Interactive Display Screens		
	Power	Regen Active	Not Ready	Metering	Energy Records	Fault Records
M3545 Series	●	●	●			
M3645 Series	●	●	●	●	●	●

with -D in Model Number

**Metering**

- DC Voltage
- DC Regen Current
- Regen Power
- Total Unit On-time

**Energy Records**

- Energy Regenerated in Lifetime
- Energy Regenerated since user reset

**Fault Records**

- Stores 50 most recent fault states (Last one record is stored with LED Indicators)
- Feedback Undervoltage, Overtemperature, DC Overvoltage, Differential Overvoltage, Sync Loss, IGBT Driver, Phase Overcurrent, Phase Loss, DC Undervoltage, Precharge Failure, Frequency Detect Failure

## Savings Calculator

Bonitron Line Regen units return regenerative energy back to the AC line where it can be used by equipment within the facility. This reduces the amount of power required from the utility; reducing utility costs.

The formula to the right is an example for a 100HP application. Visit [Bonitron.com/RegenCalculator](http://Bonitron.com/RegenCalculator) to see your potential savings.

The calculator does not include the cost of the Line Regen itself. Contact Bonitron for pricing and to discuss your application. When comparing a Line Regen to a Resistor, consider the added cost of wiring, conduit, or cooling for a resistor. While many resistors produce enough heat that they need to be located outside, Bonitron Line Regens are 99% efficient and are designed to be integrated into the drive cabinet.

[Bonitron.com/RegenCalculator](http://Bonitron.com/RegenCalculator)

<b>Formula:</b>	<b>Example:</b>
(Continuous HP)	(100)
x (Duty Cycle %)	x (0.40)
x (Days of Operation)	x (350)
x (Hours of Operation per Day)	x (12)
x (Cost per kWh)	x (0.10)
<u>x (0.746)</u>	<u>x (0.746)</u>
<b>= Savings</b>	<b>= \$12,527.76</b>

\*Contact Bonitron to discuss your application's possible savings.



[www.bonitron.com](http://www.bonitron.com)



615-244-2825

[info@bonitron.com](mailto:info@bonitron.com)





Overvoltage Solutions

Series Selection	System Voltage	Current (Continuous)	Current (Peak)	Single Phase Operation*	UL Listed	Interactive Display
M3545 Series	208 - 480VAC	2A - 15A	3A - 22.5A	●	● 15A Only	
M3645 Series	208 - 600VAC	30 - 300A	45 - 375A		●	●

\*See table below for single phase ratings

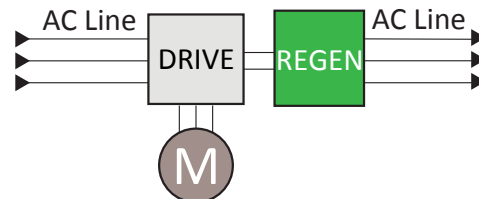
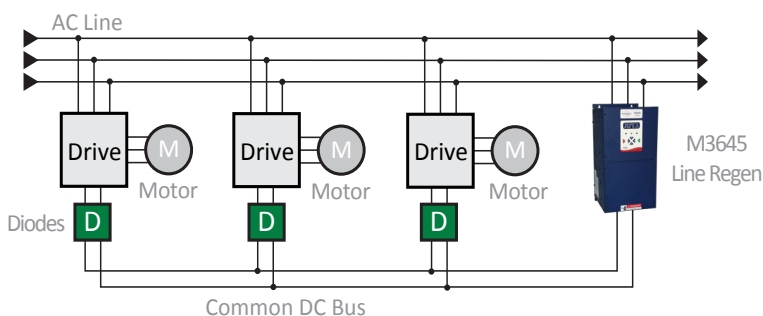

\*The M3645-X300R is required with the M3645-X300T-M15-D modules.

Phase	Line Regen							Fuse Plate Model Number	Required Reactor Model Number		
	Power		Display Type	Model Number	Current		Watt Loss				
	Cont.	Peak			Cont.	Peak					
208 - 240VAC											
1	0.9 HP	1.4 HP	LEDs	M3545-L006-C4	2 A	3 A	34 W	16" x 4.06" x 7.76"	M3545F-H015	N/A	
3	2.8 HP	4.2 HP			6 A	9 A	59 W				
1	2.25 HP	3.5 HP	LEDs	M3545-L015-M4	5 A	7.5 A	67W	17.00" x 4.70" x 10.80"			
3	7 HP	10.5 HP			15 A	22.5 A	117W				
3	14 HP	21 HP	LEDs+Digital	M3645-L030-M10-D	30 A	45 A	180W	20.00" x 10.00" x 10.10"			M3645F-H030
3	24 HP	36 HP	LEDs+Digital	M3645-L050-M11-D	50 A	75 A	265W	22.00" x 11.30" x 10.60"			M3645F-H050
3	48 HP	72 HP	LEDs+Digital	M3645-L100-M12-D	100 A	150 A	470W	24.00" x 12.00" x 12.10"	M3645F-H100		
3	72 HP	108 HP	LEDs+Digital	M3645-L150T-M15-D	150 A	225 A	1000W	26.00" x 13.90" x 11.11"	M3645F-H150	M3645-L150R	
3	108 HP	160.8 HP	LEDs+Digital	M3645-L225T-M15-D	225 A	335 A	1500W	26.00" x 13.90" x 11.11"	M3645F-H225	M3645-L225R	
3	96 HP	120 HP	LEDs+Digital	M3645-L300T-M15-D	300 A	375 A	2000W	26.00" x 13.90" x 11.11"	M3645F-H300	M3645-L300R	
380 - 415VAC											
3	25 HP	37 HP	LEDs+Digital	M3645-E030-M10-D	30 A	45 A	180W	20.00" x 10.00" x 10.10"	M3645F-H030	N/A	
3	41 HP	62 HP	LEDs+Digital	M3645-E050-M11-D	50 A	75 A	265W	22.00" x 11.30" x 10.60"	M3645F-H050		
3	83 HP	125 HP	LEDs+Digital	M3645-E100-M12-D	100 A	150 A	470W	24.00" x 12.00" x 12.10"	M3645F-H100		
3	125 HP	187.5 HP	LEDs+Digital	M3645-E150T-M15-D	150 A	225 A	1000W	26.00" x 13.90" x 11.11"	M3645F-H225		M3645-E150R
3	187.5 HP	279.2 HP	LEDs+Digital	M3645-E225T-M15-D	225 A	335 A	1500W	26.00" x 13.90" x 11.11"	M3645F-H300		M3645-E225R
3	250 HP	312.5 HP	LEDs+Digital	M3645-E300T-M15-D	300 A	375 A	2000W	26.00" x 13.90" x 11.11"	M3645F-H300		M3645-E300R
460 - 480VAC											
1	1.8 HP	2.8 HP	LEDs	M3545-H006-C4	2 A	3 A	34 W	16" x 4.06" x 7.76"	M3545F-H015	N/A	
3	5.6 HP	8.4 HP			6 A	9 A	59 W				
1	4.5 HP	7 HP	LEDs	M3545-H015-M4	5 A	7.5 A	67W	17.00" x 4.70" x 10.80"			
3	14 HP	21 HP			15 A	22.5 A	117W				
3	28 HP	43 HP	LEDs+Digital	M3645-H030-M10-D	30 A	45 A	180W	20.00" x 10.00" x 10.10"			M3645F-H030
3	48 HP	72 HP	LEDs+Digital	M3645-H050-M11-D	50 A	75 A	265W	22.00" x 11.30" x 10.60"			M3645F-H050
3	96 HP	144 HP	LEDs+Digital	M3645-H100-M12-D	100 A	150 A	470W	24.00" x 12.00" x 12.10"	M3645F-H100		
3	144 HP	216 HP	LEDs+Digital	M3645-H150T-M15-D	150 A	225 A	1000W	26.00" x 13.90" x 11.11"	M3645F-H150	M3645-H150R	
3	216 HP	321.6 HP	LEDs+Digital	M3645-H225T-M15-D	225 A	335 A	1500W	26.00" x 13.90" x 11.11"	M3645F-H225	M3645-H225R	
3	288 HP	360 HP	LEDs+Digital	M3645-H300T-M15-D	300 A	375 A	2000W	26.00" x 13.90" x 11.11"	M3645F-H300	M3645-H300R	
575 - 600VAC											
3	36 HP	54 HP	LEDs+Digital	M3645-C030-M10-D	30 A	45 A	180W	20.00" x 10.00" x 10.10"	M3645F-C030	N/A	
3	60 HP	90 HP	LEDs+Digital	M3645-C050-M11-D	50 A	75 A	265W	22.00" x 11.30" x 10.60"	M3645F-C050		
3	120 HP	180 HP	LEDs+Digital	M3645-C100-M12-D	100 A	150 A	470W	24.00" x 12.00" x 12.10"	M3645F-C100		





### Overvoltage Solutions

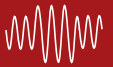

Bonitron remains a leader in the field of high horsepower braking and proudly maintains its reputation for durability and reliability, with models rated up to 1600A.

Bonitron Braking Transistors are used with AC drives to allow full power braking and eliminate overvoltage faults. This permits controlled braking and dramatically shortens motor stopping time. The M3452 works with Variable Speed Drives (VSDs) to monitor the DC bus. If overvoltage occurs, the M3452 shunts the excess energy through a braking resistor to prevent overvoltage faults. (Standard and custom braking resistors are also available from Bonitron. For more information see the M3775R series).

Optional advanced diagnostics allow for remote monitoring, while local indicators assist in pinpointing issues. Remote configuration and networking capabilities add to the flexibility and reliability of your overall system and reduce your installation wiring.



Up to 1600A per unit

## M3452 Series

### 50 - 100% Braking Duty

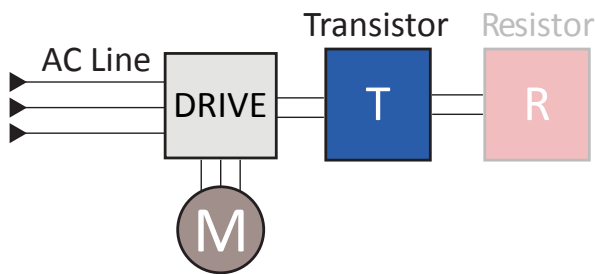

### Product Highlights

- Local and remote status monitoring
- EtherNet/IP™ & PROFIBUS™ DP networking options
- Systems can be reconfigured on-the-fly
- Up to 1600A per unit (Parallel operation for higher ratings)
- Proven record for quality and support

### Model Number Breakdown

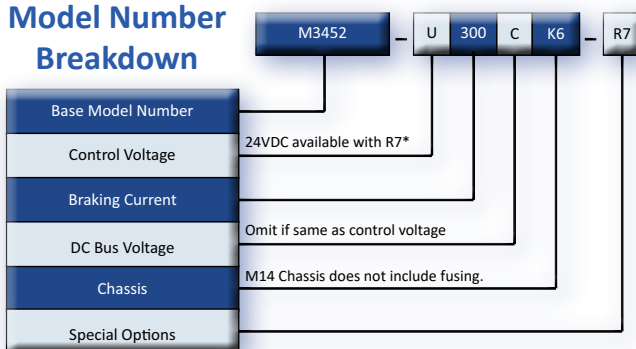

### Specifications

- Voltages**.....230 - 690VAC  
**Current Rating**.....75 to 1600Amps  
**Connections**.....Drive DC Bus  
 Input AC Line (Control)  
 Ground  
**Max. 'On-Time'**..... Peak rating for 60 seconds  
 Continuous rating - continuous



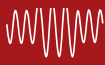

## Overvoltage Solutions



When used with  
A, R7, R7E, R7EIP/PDP  
control options. Not "E" voltage class,  
800A, 1200A, or units with the T10 chassis

### 230-240VAC

Power (Peak)	Control Voltage	Base Model Number	Braking Current (Peak)	Braking Current (RMS)	Minimum Resistance	Dimensions (H x W x D)	UL and CUL Listing
230-240 VAC Drives   375 VDC Setpoint							
37.5 HP	115-120 VAC 230-240 VAC	M3452-U75LB7 M3452-L75B7	75 A	75 A	5.00 Ω	17.75" x 7.00" x 8.10"	UL and CUL
75 HP	115-120 VAC 230-240 VAC	M3452-U150LB7 M3452-L150B7	150 A	150 A	2.50 Ω	17.75" x 7.00" x 8.10"	UL and CUL
100 HP	115-120 VAC 230-240 VAC	M3452-U200LK6 M3452-L200K6	200 A	200 A	1.90 Ω	20.00" x 7.12" x 10.50"	UL and CUL
150 HP	115-120 VAC 230-240 VAC	M3452-U300LK6 M3452-L300K6	300 A	300 A	1.25 Ω	20.00" x 7.12" x 10.50"	UL and CUL
300 HP	115-120 VAC 230-240 VAC	M3452-U600LK6 M3452-L600K6	600 A	300 A	0.63 Ω	20.00" x 7.12" x 10.50"	UL and CUL
400 HP	115-120 VAC 230-240 VAC	M3452-U800LK9 M3452-L800K9	800 A	400 A	0.47 Ω	20.00" x 9.05" x 10.25"	
600 HP	115-120 VAC 230-240 VAC	M3452-U1200LK10 M3452-L1200K10	1200 A	600 A	0.32 Ω	20.00" x 10.00" x 10.50"	

For 24VDC control voltage, replace "U" with "D". Only available with R7, R7E Options. (Not UL Listed)

### 380-415VAC

Power (Peak)	Control Voltage	Base Model Number	Braking Current (Peak)	Braking Current (RMS)	Minimum Resistance	Dimensions (H x W x D)	UL and CUL Listing
380 - 415 VAC Drives   620 VDC Setpoint							
62.5 HP	120 VAC 380 VAC	M3452-U75EB7 M3452-E75B7	75 A	75 A	8.27 Ω	17.75" x 7.00" x 8.10"	
125 HP	120 VAC 380 VAC	M3452-U150EB7 M3452-E150B7	150 A	150 A	4.13 Ω	17.75" x 7.00" x 8.10"	
160 HP	120 VAC 380 VAC	M3452-U200EK6 M3452-E200K6	200 A	200 A	3.10 Ω	20.00" x 7.12" x 10.50"	
240 HP	120 VAC 380 VAC	M3452-U300EK6 M3452-E300K6	300 A	300 A	2.07 Ω	20.00" x 7.12" x 10.50"	
490 HP	120 VAC 380 VAC	M3452-U600EK6 M3452-E600K6	600 A	300 A	1.04 Ω	20.00" x 7.12" x 10.50"	
660 HP	120 VAC 380 VAC	M3452-U800EK9 M3452-E800K9	800 A	400 A	0.78 Ω	20.00" x 9.05" x 10.25"	
1000 HP	120 VAC 380 VAC	M3452-U1200EK10 M3452-E1200K10	1200 A	600 A	0.52 Ω	20.00" x 10.00" x 10.50"	
1330 HP	120 VAC 380 VAC	M3452-U1600EM14 M3452-E1600M14	1600 A	1200 A	0.39 Ω	28.00" x 13.90" x 14.60"	
1330 HP	120 VAC 380 VAC	M3452-U1600ET10 M3452-E1600T10	1600 A	1200 A	0.39 Ω	30.59" x 10.12" x 19.18"	



M3452



When used with A, R7, R7E, R7EIP/PDP control options. Not "E" voltage class, 800A, 1200A, or units with the T10 chassis

Overvoltage Solutions



## 460-480VAC

Power (Peak)	Control Voltage	Base Model Number	Braking Current (Peak)	Braking Current (RMS)	Minimum Resistance	Dimensions (H x W x D)	UL and CUL Listing
460-480 VAC Drives   750 VDC Setpoint							
75 HP	120 VAC	M3452-U75HB7	75 A	75 A	10.00 Ω	17.75" x 7.00" x 8.10"	UL and CUL
	460 VAC	M3452-H75B7					
150 HP	120 VAC	M3452-U150HB7	150 A	150 A	5.00 Ω	17.75" x 7.00" x 8.10"	UL and CUL
	460 VAC	M3452-H150B7					
200 HP	120 VAC	M3452-U200HK6	200 A	200 A	3.80 Ω	20.00" x 7.12" x 10.50"	UL and CUL
	460 VAC	M3452-H200K6					
300 HP	120 VAC	M3452-U300HK6	300 A	300 A	2.50 Ω	20.00" x 7.12" x 10.50"	UL and CUL
	460 VAC	M3452-H300K6					
600 HP	120 VAC	M3452-U600HK6	600 A	300 A	1.25 Ω	20.00" x 7.12" x 10.50"	UL and CUL
	460 VAC	M3452-H600K6					
800 HP	120 VAC	M3452-U800HK9	800 A	400 A	0.93 Ω	20.00" x 9.05" x 10.25"	
	460 VAC	M3452-H800K9					
1200 HP	120 VAC	M3452-U1200HK10	1200 A	600 A	0.63 Ω	20.00" x 10.00" x 10.50"	
	460 VAC	M3452-H1200K10					
1600 HP	120 VAC	M3452-U1600HM14	1600 A	1200 A	0.47 Ω	28.00" x 13.90" x 14.60"	UL and CUL
	460 VAC	M3452-H1600M14					
1600 HP	120 VAC	M3452-U1600HT10	1600 A	1200 A	0.47 Ω	30.59" x 10.12" x 19.18"	
	460 VAC	M3452-H1600T10					

For 24VDC control voltage, replace "U" with "D". Only available with R7, R7E Options. (Not UL Listed)

## 575-600VAC

Power (Peak)	Control Voltage	Base Model Number	Braking Current (Peak)	Braking Current (RMS)	Minimum Resistance	Dimensions (H x W x D)	UL and CUL Listing
575-600 VAC Drives   940 VDC Setpoint							
95 HP	120 VAC	M3452-U75CB7	75 A	75 A	12.50 Ω	17.75" x 7.00" x 8.10"	UL and CUL
	575 VAC	M3452-C75B7					
190 HP	120 VAC	M3452-U150CB7	150 A	150 A	6.30 Ω	17.75" x 7.00" x 8.10"	UL and CUL
	575 VAC	M3452-C150B7					
250 HP	120 VAC	M3452-U200CK6	200 A	200 A	4.70 Ω	20.00" x 7.12" x 10.50"	UL and CUL
	575 VAC	M3452-C200K6					
380 HP	120 VAC	M3452-U300CK6	300 A	300 A	3.20 Ω	20.00" x 7.12" x 10.50"	UL and CUL
	575 VAC	M3452-C300K6					
760 HP	120 VAC	M3452-U600CK6	600 A	300 A	1.60 Ω	20.00" x 7.12" x 10.50"	UL and CUL
	575 VAC	M3452-C600K6					
1000 HP	120 VAC	M3452-U800CK9	800 A	400 A	1.20 Ω	20.00" x 9.05" x 10.25"	
	575 VAC	M3452-C800K9					
1500 HP	120 VAC	M3452-U1200CK10	1200 A	600 A	0.78 Ω	20.00" x 10.00" x 10.50"	
	575 VAC	M3452-C1200K10					
2015 HP	120 VAC	M3452-U1600CM14	1600 A	1200 A	0.58 Ω	28.00" x 13.90" x 14.60"	UL and CUL
	575 VAC	M3452-C1600M14					
2015 HP	120 VAC	M3452-U1600CT10	1600 A	1200 A	0.58 Ω	30.59" x 10.12" x 19.18"	
	575 VAC	M3452-C1600T10					





## Overvoltage Solutions

### 690VAC

Power (Peak)	Control Voltage	Base Model Number	Braking Current (Peak)	Braking Current (RMS)	Minimum Resistance	Dimensions (H x W x D)	UL and CUL Listing
690 VAC Drives   1090 VDC Setpoint							
110 HP	120 VAC	M3452-U75YB7	75 A	75 A	14.50 Ω	17.75" x 7.00" x 8.10"	
220 HP	120 VAC	M3452-U150YB7	150 A	150 A	7.30 Ω	17.75" x 7.00" x 8.10"	
300 HP	120 VAC	M3452-U200YK6	200 A	200 A	5.50 Ω	20.00" x 7.12" x 10.50"	
440 HP	120 VAC	M3452-U300YK6	300 A	300 A	3.60 Ω	20.00" x 7.12" x 10.50"	
875 HP	120 VAC	M3452-U600YK6	600 A	300 A	1.95 Ω	20.00" x 7.12" x 10.50"	
1170 HP	120 VAC	M3452-U800YK9	800 A	400 A	1.40 Ω	20.00" x 9.05" x 10.25"	
1750 HP	120 VAC	M3452-U1200YK10	1200 A	600 A	0.91 Ω	20.00" x 10.00" x 10.50"	
2300 HP	120 VAC	M3452-U1600YM14	1600 A	1200 A	0.68 Ω	28.00" x 13.90" x 14.60"	



## M3452 Series

### Network and Control Options

Control Options	A	R7	R7E	R7EIP	R7PDP	R7PNET
Enable						
Master/Slave						
Bus Discharge						
Fault Reset						
Module Ready						
Logic Power OK						
Not IGBT Open						
Not IGBT Shorted						
Not Overtemp						
Not Blown Fuse						
Control Ready						
Master/Slave Status						
Power Stage Ready						
Not Overcurrent						
Blink Codes						

EtherNet/IP is registered trademark of ODVA. PROFIBUS is a registered trademark of PROFIBUS Trade Organization.



Discrete Hardwire Connection



Ethernet Network Connection



Profibus Network Connection



Profinet Network Connection

- 75 - 150A (B7) Options Available with "A" Only
- 1200A (K10) and 1600A (M14) Options R7, R7E, R7EIP, R7PDP, R7PNET
- 1600A (T10) Options R7, R7E, R7EIP, R7PDP, R7PNET
- All units above 200A have Master/Slave capability



www.bonitron.com



615-244-2825

info@bonitron.com



### Overvoltage Solutions



Bonitron Braking Transistors are used with AC drives to allow full power braking and eliminate overvoltage faults. This permits controlled braking and dramatically shortens motor stopping time. **The M3575T and M3675T series are ideal for drives with no internal braking transistor** and work with variable frequency drives to monitor the DC bus. If overvoltage occurs, the braking transistor shunts the excess energy through a braking resistor to **prevent overvoltage faults**.



**M3575T**  
Series



**M3675T**  
Series

### 20% Braking Duty

	Peak HP	Model Number	Peak Current	Cont. Current	Min. Resistance	Dimensions (H x W x D)	UL and CUL Listing
<b>115 - 120VAC   190 VDC Setpoint</b>							
	2.5HP	M3675T-U10	10A	2A	19Ω	7.00" x 2.06" x 6.75"	
<b>230 - 240VAC   375VDC Setpoint</b>							
	5HP	M3675T-L10	10A	2A	38Ω	7.00" x 2.06" x 6.75"	
	8HP	<b>M3575T-L15</b>	15A	3.8A	25Ω	12.75" x 3.00" x 8.70"	UL and CUL
	15HP	<b>M3575T-L30</b>	30A	7.75A	12.5Ω	12.75" x 3.00" x 8.70"	UL and CUL
	30HP	<b>M3575T-L60</b>	60A	15A	6.25Ω	12.75" x 4.00" x 8.70"	UL and CUL
	63HP	M3575T-L125	125A	32A	3Ω	17.75" x 6.50" x 8.00"	
	75HP	M3575T-L150	150A	38A	2.5Ω	17.75" x 6.50" x 8.00"	
	100HP	M3575T-L200	200A	51A	1.9Ω	17.75" x 7.00" x 8.00"	
	150HP	M3575T-L300	300A	77A	1.3Ω	17.75" x 7.00" x 8.00"	
	300HP	M3575T-L600	600A	155A	0.7Ω	17.75" x 7.00" x 8.00"	
<b>380 - 415VAC   620VDC Setpoint</b>							
	7.5HP	M3675T-E10	10A	2A	62Ω	7.00" x 2.06" x 6.75"	
	12.5HP	M3575T-E15	15A	3.8A	41.25Ω	12.75" x 3.00" x 8.70"	
	25HP	M3575T-E30	30A	7.75A	20.5Ω	12.75" x 3.00" x 8.70"	
	63HP	M3575T-E75	75A	19A	8.25Ω	12.75" x 4.00" x 8.70"	
	100HP	M3575T-E125	125A	32A	5Ω	17.75" x 6.50" x 8.00"	
	125HP	M3575T-E150	120A	38A	4.1Ω	17.75" x 6.50" x 8.00"	
	165HP	M3575T-E200	200A	51A	3.1Ω	17.75" x 7.00" x 8.00"	
	240HP	M3575T-E300	300A	77A	2Ω	17.75" x 7.00" x 8.00"	
	530HP	M3575T-E600	600A	155A	1.1Ω	17.75" x 7.00" x 8.00"	
<b>460 - 480VAC   750VDC Setpoint</b>							
	10HP	M3675T-H10	10A	2A	75Ω	7.00" x 2.06" x 6.75"	
	15HP	<b>M3575T-H15</b>	15A	3.8A	50Ω	12.75" x 3.00" x 7.70"	UL and CUL
	30HP	<b>M3575T-H30</b>	30A	7.75A	25Ω	12.75" x 3.00" x 7.70"	UL and CUL
	75HP	<b>M3575T-H75</b>	75A	19A	10Ω	12.75" x 4.00" x 7.70"	UL and CUL
	125HP	M3575T-H125	125A	32A	6Ω	17.75" x 6.50" x 8.00"	
	150HP	M3575T-H150	150A	38A	5Ω	17.75" x 6.50" x 8.00"	
	200HP	M3575T-H200	200A	51A	3.75Ω	17.75" x 7.00" x 8.00"	
	300HP	M3575T-H300	300A	77A	2.5Ω	17.75" x 7.00" x 8.00"	
	600HP	M3575T-H600	600A	155A	1.25Ω	17.75" x 7.00" x 8.00"	





## Overvoltage Solutions

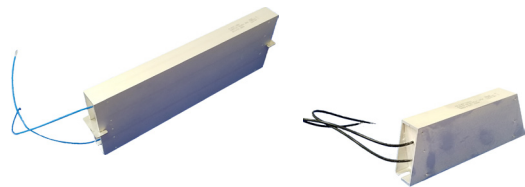

## Case Resistors

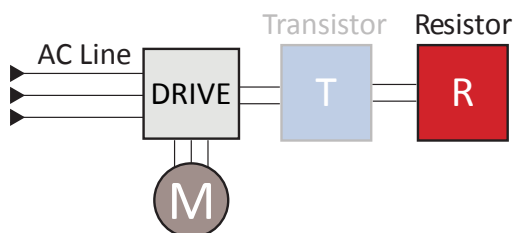

Bonitron now offers case resistors for applications up to 20 HP, which are a great add-on solution due to their small size and cost.

Like the rest of Bonitron's resistor offering, Case Resistors protect drives from overvoltage faults by dissipating excess regenerative energy as heat. Case Resistors are used in applications where infrequent, low duty cycle, or low horsepower regeneration occurs.

Case resistors are commonly used with a drive's internal brake or a Bonitron M3675T Braking Transistor.

For resistors rated up to the megawatts, see the Bonitron M3575R or M3775R Series. Custom resistors are also available.

### Product Highlights

1 - 20 HP

- UL & cUL Listed
- Aluminium housing
- Two-screw mounting
- Installable with new application or as retrofit
- Rapid installation increases up time
- IP 65 rated

## Model Selection

Model Number	Drive HP	Peak Watts	Cont. Watts	Braking Torque	Resistance (Ohms)	L (inches)
230 - 240 VAC						
RS CRKL001HP	1	1125	200	150%	125	6.6
RS CRKL002HP	2	2250	240	150%	65	8.5
RS CRKL005HP	5	5625	300	150%	25	10.5
460 - 480 VAC						
RS CRKH001HP	1	1125	300	150%	500	10.5
RS CRKH002HP	2	2250	240	150%	250	8.5
RS CRKH005HP	5	5625	300	150%	100	10.5

10% Duty rated for 10 seconds on, 90 seconds off



## M3775R

### Overvoltage Solutions

While Bonitron has been the industry leader for Braking Transistors for years, what better way to compliment that than by offering quality resistors too! Bonitron has a vast standard offering of Braking Resistors and welcomes custom requests as well.

M3775R Braking Resistors are used with Bonitron Braking Transistors to allow full power braking and eliminate overvoltage faults. This permits controlled braking and dramatically shortens motor stopping, time. If overvoltage occurs, Bonitron Transistors or the drive's internal brake, shunts excess energy through a Bonitron M3775R Braking Resistor to prevent overvoltage faults.

UL listing option can be quoted for M3775R.



## M3775R Series

### Convection Cooled



- A - 10% Duty
- B - 50% Duty
- C - 100% Duty

- L - 230 - 240VAC
- E - 380 - 415VAC
- H - 460 - 480VAC
- C - 575 - 600VAC
- Y - 690VAC

- VFA - Vertical Fan Exhaust
- HFA - Horizontal Fan Exhaust

### Model Number Breakdown

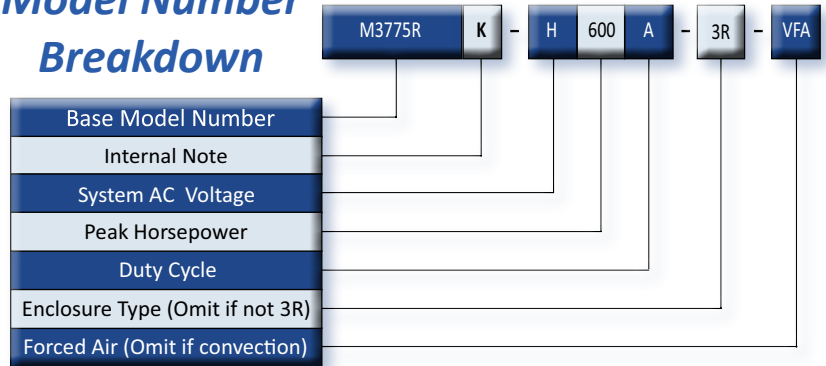

### Vertical Forced Air (VFA)

### Product Highlights

- Standard Mill Galvanized Steel Enclosure
  - 306, 316, etc. Stainless Steel Options
- NEMA-3R Options
- **Thermal switch comes standard**

**Voltages**.....230 - 690VAC  
**Current Rating**.....Up to 1600Amps  
**Duty Cycle**.....10 % Overhauling/ 20% Braking  
 50% Overhauling  
 100% Overhauling





## Overvoltage Solutions



## M3575R Series

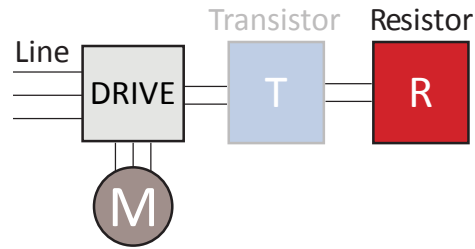

### Product Highlights

- UL & cUL Listed
- Wall or cabinet mountable
- Installable with new application or as retrofit
- Rapid installation increases up time
- Terminal access covers are standard

## 230 - 240VAC

	230 - 240VAC   375VDC Setpoint					
	Braking HP	Model Number	Power		Resistance	Dimensions (H x W x D)
			Peak	Cont.		
<b>6% Duty</b>						
1 HP	<b>M3575R-L1M0</b>	746 W	46 W	190 Ω	12.75" x 4.00" x 9.50"	
2 HP	<b>M3575R-L2M0</b>	1492 W	91 W	95 Ω	12.75" x 4.00" x 9.50"	
3 HP	<b>M3575R-L3M0</b>	2238 W	137 W	63 Ω	12.75" x 4.00" x 9.50"	
4 HP	<b>M3575R-L4M0</b>	2984 W	182 W	48 Ω	12.75" x 7.00" x 9.50"	
5 HP	<b>M3575R-L5B0</b>	3730 W	243 W	38 Ω	17.75" x 4.00" x 9.50"	
6 HP	<b>M3575R-L6M0</b>	4476 W	274 W	32 Ω	12.75" x 7.00" x 9.50"	
8 HP	<b>M3575R-L8B0</b>	5968 W	365 W	25 Ω	17.75" x 4.00" x 9.50"	
9 HP	<b>M3575R-L9M0</b>	6714 W	410 W	21 Ω	12.75" x 10.00" x 9.50"	
11 HP	<b>M3575R-L11B0</b>	8206 W	486 W	19 Ω	17.75" x 7.00" x 9.50"	
16 HP	<b>M3575R-L16B0</b>	11936 W	730 W	13 Ω	17.75" x 7.00" x 9.50"	
24 HP	<b>M3575R-L24B0</b>	17904 W	1094 W	8 Ω	17.75" x 10.00" x 9.50"	
<b>20% Duty</b>						
1 HP	<b>M3575R-L1MF</b>	746 W	152 W	190 Ω	12.75" x 4.00" x 9.50"	
2 HP	<b>M3575R-L2MF</b>	1492 W	304 W	95 Ω	12.75" x 4.00" x 9.50"	
3 HP	<b>M3575R-L3MF</b>	2238 W	456 W	63 Ω	12.75" x 4.00" x 9.50"	
4 HP	<b>M3575R-L4MF</b>	2984 W	608 W	48 Ω	12.75" x 7.00" x 9.50"	
5 HP	<b>M3575R-L5BF</b>	3730 W	811 W	38 Ω	17.75" x 4.00" x 9.50"	
6 HP	<b>M3575R-L6MF</b>	4476 W	912 W	32 Ω	12.75" x 7.00" x 9.50"	
8 HP	<b>M3575R-L8BF</b>	5968 W	1216 W	25 Ω	17.75" x 4.00" x 9.50"	
9 HP	<b>M3575R-L9MF</b>	6714 W	1368 W	21 Ω	12.75" x 10.00" x 9.50"	
11 HP	<b>M3575R-L11BF</b>	8206 W	1621 W	19 Ω	17.75" x 7.00" x 9.50"	
16 HP	<b>M3575R-L16BF</b>	11936 W	2432 W	13 Ω	17.75" x 7.00" x 9.50"	
24 HP	<b>M3575R-L24BF</b>	17904 W	3648 W	8 Ω	17.75" x 10.00" x 9.50"	





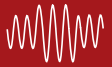

Bonitron M3575R Braking Resistors help protect drives from overvoltage faults by dissipating excess regenerative energy as heat. M3575R Braking Resistors are commonly used in applications where infrequent, low duty cycle, or low horsepower regeneration occurs.

M3575R Braking Resistors are easily applied as resistive loads for use with a drive's internal or external braking transistor. Sizes up to 33 horsepower in a single unit are available and may be paralleled for higher requirements. Units have been designed and tested to ensure that cabinet temperatures are less than 85° Celsius.

For resistors rated up to the megawatts see the Bonitron M3775R Resistive Load Bank Series. Custom resistors are also available.

### 460 - 480VAC

	460 - 480VAC   750VDC Setpoint					
	Drive HP	Model Number	Power		Resistance	Dimensions (H x W x D)
			Peak	Cont.		
<b>6% Duty</b>						
1 HP	<b>M3575R-H1M0</b>	746 W	45 W	780 Ω	12.75" x 4.00" x 9.50"	
2 HP	<b>M3575R-H2M0</b>	1492 W	90 W	390 Ω	12.75" x 4.00" x 9.50"	
3 HP	<b>M3575R-H3M0</b>	2238 W	135 W	260 Ω	12.75" x 4.00" x 9.50"	
4 HP	<b>M3575R-H4M0</b>	2984 W	180 W	195 Ω	12.75" x 7.00" x 9.50"	
5 HP	<b>M3575R-H5B0</b>	3730 W	225 W	150 Ω	17.75" x 4.00" x 9.50"	
6 HP	<b>M3575R-H6M0</b>	4476 W	270 W	130 Ω	12.75" x 7.00" x 9.50"	
8 HP	<b>M3575R-H8B0</b>	5968 W	360 W	90 Ω	17.75" x 4.00" x 9.50"	
9 HP	<b>M3575R-H9M0</b>	6714 W	405 W	87 Ω	12.75" x 10.00" x 9.50"	
11 HP	<b>M3575R-H11B0</b>	8206 W	495 W	60 Ω	17.75" x 7.00" x 9.50"	
16 HP	<b>M3575R-H16B0</b>	11936 W	720 W	45 Ω	17.75" x 7.00" x 9.50"	
24 HP	<b>M3575R-H24B0</b>	17904 W	1080 W	30 Ω	17.75" x 10.00" x 9.50"	
<b>20% Duty</b>						
1 HP	<b>M3575R-H1MF</b>	746 W	150 W	780 Ω	12.75" x 4.00" x 9.50"	
2 HP	<b>M3575R-H2MF</b>	1492 W	300 W	390 Ω	12.75" x 4.00" x 9.50"	
3 HP	<b>M3575R-H3MF</b>	2238 W	450 W	260 Ω	12.75" x 4.00" x 9.50"	
4 HP	<b>M3575R-H4MF</b>	2984 W	600 W	195 Ω	12.75" x 7.00" x 9.50"	
5 HP	<b>M3575R-H5BF</b>	3730 W	750 W	150 Ω	17.75" x 4.00" x 9.50"	
6 HP	<b>M3575R-H6MF</b>	4476 W	900 W	130 Ω	12.75" x 7.00" x 9.50"	
8 HP	<b>M3575R-H8BF</b>	5968 W	1200 W	90 Ω	17.75" x 4.00" x 9.50"	
9 HP	<b>M3575R-H9MF</b>	6714 W	1350 W	87 Ω	12.75" x 10.00" x 9.50"	
11 HP	<b>M3575R-H11BF</b>	8206 W	1650 W	60 Ω	17.75" x 7.00" x 9.50"	
16 HP	<b>M3575R-H16BF</b>	11936 W	2400 W	45 Ω	17.75" x 7.00" x 9.50"	
24 HP	<b>M3575R-H24BF</b>	17904 W	3600 W	30 Ω	17.75" x 10.00" x 9.50"	
28 HP	<b>M3575R-H27BF</b>	20888 W	1800 W	28.2 Ω	17.75" x 10.00" x 9.50"	
33 HP	<b>M3575R-H33BF</b>	24618 W	3600 W	22.5 Ω	17.75" x 10.00" x 11.50"	



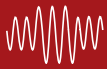

## Overvoltage Solutions



Combination Braking Modules are used with AC drives to allow full power braking and eliminate overvoltage faults. This permits controlled braking and dramatically shortens motor stopping time. Bonitron Combination Braking Modules work with variable frequency drives to monitor the DC bus. If overvoltage occurs, the internal transistor shunts the excess energy through an internal braking resistor to prevent overvoltage faults.

Combination Braking Modules include a braking transistor and resistor in one convenient enclosure. This makes installation much quicker, as it eliminates the need to wire separate components.

## M3452 Complete Series

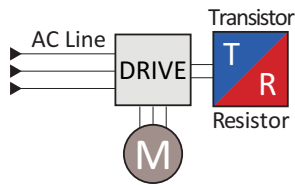

### Product Highlights

- 230 - 600 VAC | Up to 43HP
- NEMA-1 enclosure
- Transistor and resistor in one package
- Requires less installation wiring
- Reduced footprint
- Simple connection to the DC bus

Peak HP	Model Number	Cont. Watts	Resistance	Duty Cycle		Dimensions (H x W x D)	UL and CUL Listing
				Braking	Overhauling		
<b>230-240 VAC   375VDC Setpoint</b>							
6.3 HP	<b>M3452-L2B-R030</b>	400 W	30 Ω	20%	10%	18.25" x 9.50" x 8.50"	UL and CUL
6.3 HP	<b>M3452-L3B-R030</b>	600 W	30 Ω	20%	10%	18.25" x 9.50" x 8.50"	UL and CUL
9.4 HP	<b>M3452-L3B-R020</b>	600 W	20 Ω	20%	10%	18.25" x 9.50" x 8.50"	UL and CUL
12.6 HP	<b>M3452-L9C-R015</b>	1800 W	15 Ω	40%	20%	18.25" x 11.50" x 10.50"	UL and CUL
18.9 HP	<b>M3452-L6B-R010</b>	1200 W	10 Ω	20%	10%	18.25" x 9.50" x 8.50"	UL and CUL
28.1 HP	<b>M3452-L9C-R007</b>	1800 W	6.7 Ω	20%	10%	18.25" x 11.50" x 10.50"	UL and CUL
42.8 HP	<b>M3452-L8C-R004</b>	1600 W	4.4 Ω	10%	5%	18.25" x 11.50" x 10.50"	UL and CUL
<b>460-480 VAC   750VDC Setpoint</b>							
6.3 HP	<b>M3452-H2B-R120</b>	400 W	120 Ω	20%	10%	18.25" x 9.50" x 8.50"	UL and CUL
7.0 HP	<b>M3452-H9C-R108</b>	1800 W	108 Ω	60%	30%	18.25" x 11.50" x 10.50"	UL and CUL
10.1 HP	<b>M3452-H3B-R075</b>	600 W	75 Ω	20%	10%	18.25" x 9.50" x 8.50"	UL and CUL
15.1 HP	<b>M3452-H9C-R050</b>	1800 W	50 Ω	30%	15%	18.25" x 11.50" x 10.50"	UL and CUL
20.1 HP	<b>M3452-H6B-R038</b>	1200 W	37.5 Ω	20%	10%	18.25" x 9.50" x 8.50"	UL and CUL
30.2 HP	<b>M3452-H9C-R025</b>	1800 W	25 Ω	20%	10%	18.25" x 11.50" x 10.50"	UL and CUL
43.1 HP	<b>M3452-H8C-R018</b>	1600 W	17.5 Ω	10%	5%	18.25" x 11.50" x 10.50"	UL and CUL
<b>575 - 600 VAC   940VDC Setpoint</b>							
9.9 HP	<b>M3452-C2B-R120</b>	400 W	120 Ω	10%	5%	18.25" x 9.50" x 8.50"	UL and CUL
11.0 HP	<b>M3452-C9C-R108</b>	1800 W	108 Ω	60%	30%	18.25" x 11.50" x 10.50"	UL and CUL
11.3 HP	<b>M3452-C3B-R105</b>	600 W	105 Ω	15%	8%	18.25" x 9.50" x 8.50"	UL and CUL
22.6 HP	<b>M3452-C6B-R053</b>	1200 W	52.5 Ω	20%	10%	18.25" x 9.50" x 8.50"	UL and CUL
23.7 HP	<b>M3452-C9C-R050</b>	1800 W	50 Ω	20%	10%	18.25" x 11.50" x 10.50"	UL and CUL
33.8 HP	<b>M3452-C9C-R035</b>	1800 W	35 Ω	20%	10%	18.25" x 11.50" x 10.50"	UL and CUL



### Overvoltage Solutions



The M3500DB Series enhances system performance and safety by providing resistive braking control for emergency stop applications if regenerative braking does not perform.

The M3500DB series provides e-stop braking for servo motion systems and conforms to EN-954 category II or category IV safety requirements. As the secondary brake, the M3500DB stops the motor in case of motion controller or power failure. It also isolates the motor from its power source once it is stopped to increase safety.



## M3500DB Series

	Model Number		Contact Type	Resistance	Dimensions (H x W x D)
	EN-954 Category II	EN-954 Category IV			
<b>32A Continuous Motor Current</b>					
	M3500DB-H01A-32	M3500DB4-H01A-32	Normally Closed	1Ω	15.95" x 2.92" x 10.35"
	M3500DB-H01B-32	M3500DB4-H01B-32	Normally Open		
	M3500DB-H03A-32	M3500DB4-H03A-32	Normally Closed	3Ω	15.95" x 2.92" x 10.35"
	M3500DB-H03B-32	M3500DB4-H03B-32	Normally Open		
	M3500DB-H06A-32	M3500DB4-H06A-32	Normally Closed	6Ω	15.95" x 2.92" x 10.35"
	M3500DB-H06B-32	M3500DB4-H06B-32	Normally Open		
	M3500DB-H16A-32	M3500DB4-H16A-32	Normally Closed	16Ω	15.95" x 2.92" x 10.35"
	M3500DB-H16B-32	M3500DB4-H16B-32	Normally Open		
	M3500DB-H36A-32	M3500DB4-H36A-32	Normally Closed	36Ω	15.95" x 2.92" x 10.35"
	M3500DB-H36B-32	M3500DB4-H36B-32	Normally Open		
	M3500DB-H01A-32X	M3500DB4-H01A-32X	Normally Closed	1Ω	15.95" x 2.92" x 10.35"
	M3500DB-H01B-32X	M3500DB4-H01B-32X	Normally Open		
	M3500DB-H03A-32X	M3500DB4-H03A-32X	Normally Closed	3Ω	15.95" x 2.92" x 10.35"
	M3500DB-H03B-32X	M3500DB4-H03B-32X	Normally Open		
	M3500DB-H06A-32X	M3500DB4-H06A-32X	Normally Closed	6Ω	15.95" x 2.92" x 10.35"
	M3500DB-H06B-32X	M3500DB4-H06B-32X	Normally Open		
	M3500DB-H16A-32X	M3500DB4-H16A-32X	Normally Closed	16Ω	15.95" x 2.92" x 10.35"
	M3500DB-H16B-32X	M3500DB4-H16B-32X	Normally Open		
	M3500DB-H36A-32X	M3500DB4-H36A-32X	Normally Closed	36Ω	15.95" x 2.92" x 10.35"
	M3500DB-H36B-32X	M3500DB4-H36B-32X	Normally Open		
<b>43A Continuous Motor Current</b>					
	M3500DB-H01A-43	M3500DB4-H01A-43	Normally Closed	1Ω	15.95" x 2.92" x 10.35"
	M3500DB-H01B-43	M3500DB4-H01B-43	Normally Open		
	M3500DB-H03A-43	M3500DB4-H03A-43	Normally Closed	3Ω	15.95" x 2.92" x 10.35"
	M3500DB-H03B-43	M3500DB4-H03B-43	Normally Open		
<b>65A Continuous Motor Current</b>					
	M3500DB-H0.5A-65		Normally Closed	0.5Ω	15.95" x 7.56" x 10.52"
	M3500DB-H1.5A-65	N/A	Normally Closed	1.5Ω	15.95" x 7.56" x 10.52"
	M3500DB-H03A-65		Normally Closed	3Ω	15.95" x 7.56" x 10.52"
<b>150A Continuous Motor Current</b>					
		M3500DB4-H025A-150	Normally Closed	0.25Ω	20.00" x 10.00" x 10.25"
	N/A	M3500DB4-H0.75A-150	Normally Closed	0.75Ω	20.00" x 10.00" x 10.25"
		M3500DB4-H1.5A-150	Normally Closed	1.5Ω	20.00" x 10.00" x 10.25"



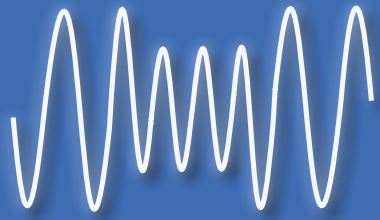

## *Undervoltage Solutions*

### **UPD Ride-Thru Systems**

- Sag Systems
- Capacitor Systems
- Battery Systems

### **UPD Ride-Thru Lite Voltage Regulators**

- M3460R
- M3460B
- M3534

### **Chargers**

- M5628
- M3528

### **Energy Storage**

- M3528B

### **Digital Display**

- KIT3660DD5

### **Dischargers**

- KIT3628



# Understanding Ride-Thru Applications

## What is Ride-Thru?

The Bonitron Sag UPD Ride-Thru systems provide protection from 60% 3-phase AC line voltage sags or the loss of one phase for up to 2 seconds without loss of motor speed or torque.

The Bonitron Outage UPD Ride-Thru systems provide protection from AC line voltage sags or the loss of all three phases for up to 15 minutes.

Bonitron UPD Ride-Thru systems are designed for AC drive systems that use a fixed DC bus, such as AC variable speed drives (VSD). Unfortunately, VSDs are quite susceptible to fluctuations in incoming power. Bonitron UPD Ride-Thru systems provide the security of “riding through” these events.

*DC Bus with Ride-Thru Protection*

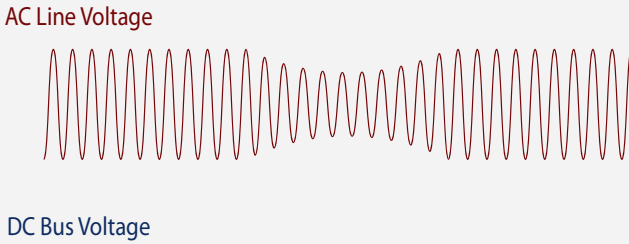

*Unprotected DC Bus*

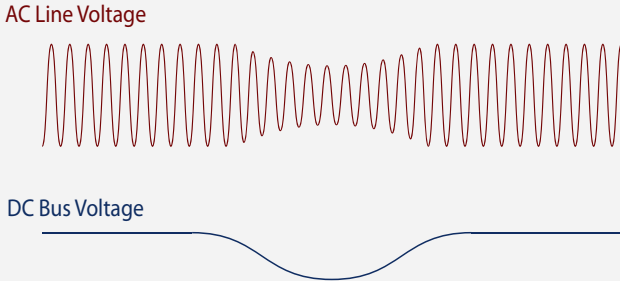

**Bonitron UPD Ride-Thru System Selection**

		Ride-Thru Duration	Voltage Regulator	Charger	Energy Storage	Discharger	Interactive Display
<b>SAG</b>	S3534SR	Sag 2 sec	●	N/A	N/A	N/A	●
	S3460SR	Sag 2 sec	●	N/A	N/A	N/A	●
<b>OUTAGE (CAPACITOR)</b>	S3534EC	Outage 0.5 sec	N/A	N/A	Electrolytic	N/A	
	S3534CR	Outage 2 sec	●	●	Electrolytic	●	Optional
	S3534UR	Outage 15 sec	●	●	Ultracapacitor	●	●
	S3460UR	Outage 15 sec	●	●	Ultracapacitor	●	●
<b>OUTAGE (BATTERY)</b>	S3534BR	Outage Up to 60 sec	●	●	Battery	N/A	●
	S3460BR	Outage Up to 15 min	●	●	Battery	N/A	●



## Undervoltage Solutions

Electricity travels miles to reach the drives and motors that control your process. While outdoor power lines and substations are vulnerable to power outages caused by cars, weather, and even animals, the lines inside your plant are susceptible to power quality events as well.

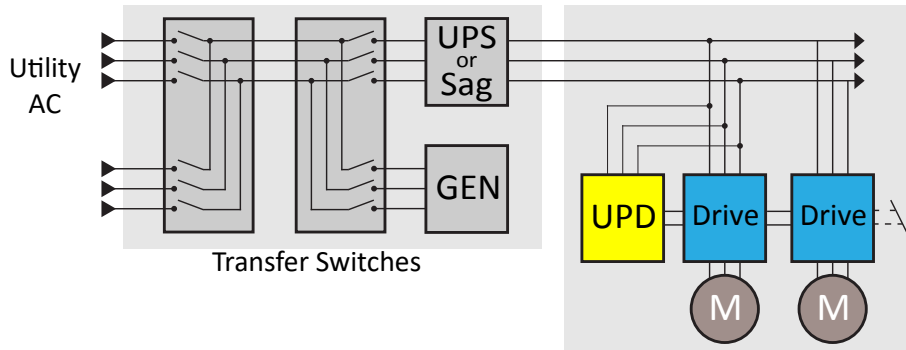

Unlike typical plant wide solutions, Bonitron designed its UPD solutions to connect directly to the DC terminals of one or multiple drives. If drive voltage sags, the Bonitron UPD immediately provides power so motor speed is not affected and the process never sees a disturbance. When properly sized, Bonitron UPD systems provide drives with full-load power until the AC line is restored or generators are online.

*Bonitron Battery UPD Systems use battery DC energy to power the DC bus of the drive via DC bus connection terminals on the drive. This eliminates an unnecessary and energy-wasting DC to AC conversion.*

### Bonitron UPD Advantages

- Parallel Connection
  - High reliability
  - Seamless power source transfer
- Increased efficiency
  - Ultra-low standby power
  - Sized to drive system for reduced cost
  - Power supplied to DC bus for minimal conversions

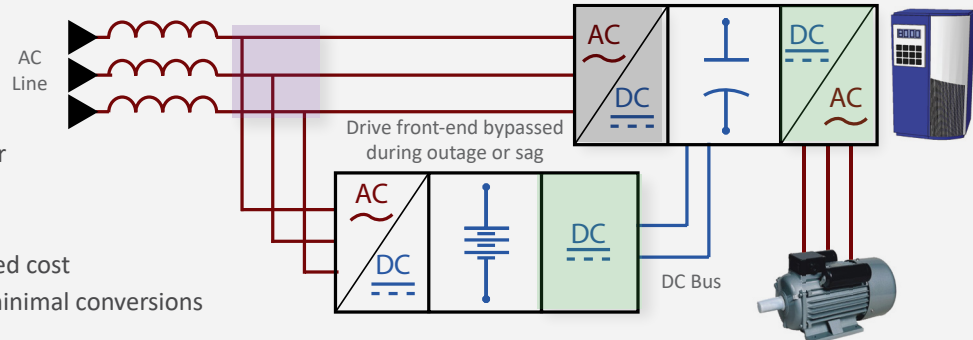

*Competitors' double conversion UPS systems convert DC voltage that is stored in batteries or capacitors back to AC voltage in order to power the drive, which in turn converts it back to DC. Variable frequency drives are not recommended for use with UPS Systems, as the drive input reactance interacts negatively with UPS inverters.*

### In-line UPS Disadvantages

- Series Connection
  - Decreased reliability
- Decreased efficiency
  - Unnecessary conversions
  - Converts energy storage back to AC

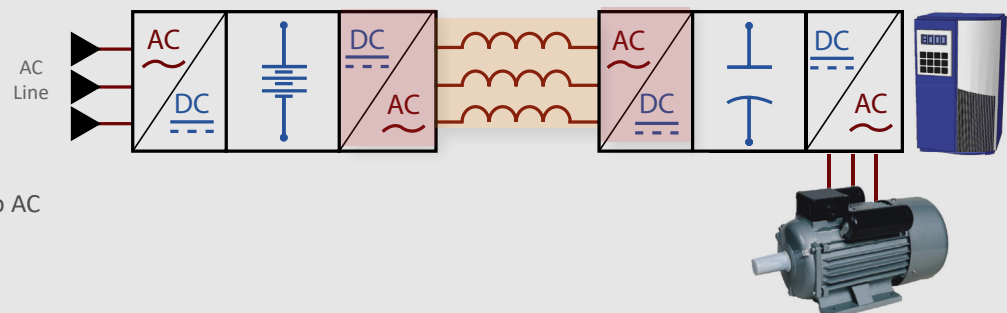

### Undervoltage Solutions

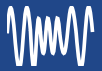

Bonitron UPD Systems (Uninterruptible Power for Drives) are the cost effective way to ensure your critical process never sees power disturbances from voltage sags or **outages lasting up to 4 minutes**. Bonitron UPD Systems include a voltage regulator that monitors the drive's DC bus voltage. If drive voltage sags or disappears, the system becomes active immediately and provides power to the DC bus so that the process is not affected.



### Product Highlights

#### Sag UPD Ride-Thru Systems

- No energy storage required
- Full load power for up to 2 seconds
  - 60% 3-phase sags
  - Single phase sag to 0V

#### Capacitor UPD Ride-Thru Systems

- Electrolytic or ultracapacitor energy storage
- Full load power for up to 15 seconds
  - 100%, 3-phase outages

#### Battery UPD Ride-Thru Systems

- Battery energy storage
- Full-load power for up to 30 minutes
  - 100%, 3-phase outages

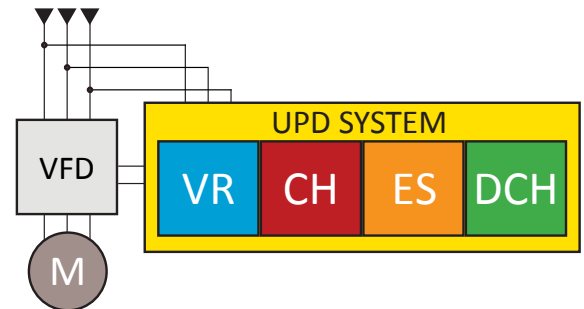

## Uninterruptible Power for Drives (UPD)

#### Sized to drive system process

- Typically much lower cost than plant-wide UPS
- Support single or multiple drives with one UPD System

#### Parallel Connection

- High reliability
- Test system with no effect on process
- Very low standby power

#### Seamless power transfer from utility, to Bonitron, to generator or restored utility

- 208 – 575VAC systems





## Undervoltage Solutions

Bonitron Undervoltage Ride-Thru Solutions, also known as Uninterruptible Power for Drives, include a DC Voltage Regulator (M3460B or M3460R) that monitors the drive. If the drive voltage sags or disappears, the Voltage Regulator becomes active and provides power to the DC bus. This allows critical processes to never see the disturbance and can continue operating at full power. Thanks to Bonitron's parallel connection, very low standby power and long product life can be expected.

## M3460R Series



### Digital Display

*The KIT 3660DD5 is an interactive digital display for the 3460 Series that monitors and stores history of power quality issues, including status, voltage, and current.*

System Power	Peak Current	Max. On-time at Rating	Model Number	Dimensions (H x W x D)
<b>230 - 240 VAC</b>				
25 kW	85 A	2 Seconds	<b>M3460R-L025-R10-F</b>	28.00" x 16.00" x 14.00"
38 kW	127 A	2 Seconds	<b>M3460R-L038-R10-F</b>	28.00" x 16.00" x 14.00"
50 kW	170 A	2 Seconds	<b>M3460R-L050-R9-F</b>	34.00" x 16.00" x 14.00"
75 kW	255 A	2 Seconds	<b>M3460R-L075-R11-F</b>	44.00" x 16.00" x 14.00"
100 kW	340 A	2 Seconds	<b>M3460R-L100-R11-F</b>	44.00" x 16.00" x 14.00"
125 kW	425 A	2 Seconds	<b>M3460R-L125-R11-F</b>	44.00" x 16.00" x 14.00"
<b>380 - 415 VAC</b>				
43 kW	85 A	2 Seconds	<b>M3460R-E043-R10-F</b>	28.00" x 16.00" x 14.00"
65 kW	127 A	2 Seconds	<b>M3460R-E065-R10-F</b>	28.00" x 16.00" x 14.00"
87 kW	170 A	2 Seconds	<b>M3460R-E087-R9-F</b>	34.00" x 16.00" x 14.00"
130 kW	255 A	2 Seconds	<b>M3460R-E130-R11-F</b>	44.00" x 16.00" x 14.00"
175 kW	340 A	2 Seconds	<b>M3460R-E175-R11-F</b>	44.00" x 16.00" x 14.00"
215 kW	425 A	2 Seconds	<b>M3460R-E215-R11-F</b>	44.00" x 16.00" x 14.00"
<b>433 - 480 VAC</b>				
50 kW	85 A	2 Seconds	<b>M3460R-H050-R10-F</b>	28.00" x 16.00" x 14.00"
75 kW	127 A	2 Seconds	<b>M3460R-H075-R10-F</b>	28.00" x 16.00" x 14.00"
100 kW	170 A	2 Seconds	<b>M3460R-H100-R9-F</b>	34.00" x 16.00" x 14.00"
150 kW	255 A	2 Seconds	<b>M3460R-H150-R11-F</b>	44.00" x 16.00" x 14.00"
200 kW	340 A	2 Seconds	<b>M3460R-H200-R11-F</b>	44.00" x 16.00" x 14.00"
250 kW	425 A	2 Seconds	<b>M3460R-H250-R11-F</b>	44.00" x 16.00" x 14.00"
<b>575 - 600 VAC</b>				
60 kW	85 A	2 Seconds	M3460R-C060-R10	28.00" x 16.00" x 14.00"
90 kW	127 A	2 Seconds	M3460R-C090-R10	28.00" x 16.00" x 14.00"
125 kW	170 A	2 Seconds	M3460R-C125-R9	34.00" x 16.00" x 14.00"
185 kW	255 A	2 Seconds	M3460R-C185-R11	44.00" x 16.00" x 14.00"
245 kW	340 A	2 Seconds	M3460R-C245-R11	44.00" x 16.00" x 14.00"
305 kW	425 A	2 Seconds	M3460R-C305-R11	44.00" x 16.00" x 14.00"





M3460B

Undervoltage Solutions 



## M3460B Series



### M3460R vs. M3460B

#### M3460R

- Protect drives and processes from 2-second power sags
- Used with energy storage to protect from outages lasting up to 15 seconds
  - electrolytic
  - ultracapacitors

#### M3460B

- Battery Voltage Regulators are used with energy storage, such as batteries, to protect drives and processes from outages lasting up to 15 minutes to allow time for generator start-up
- With seamless power transfer, the M3534B or M3460B allow seamless power transfer from the grid to generator.

System Power	Peak Current	Max. On-time at Rating	Model Number	Dimensions (H x W x D)
<b>230 - 240 VAC</b>				
25 kW	85 A	4 Minutes	<b>M3460B-L025-240-R10</b>	28.00" x 16.00" x 14.00"
38 kW	127 A	4 Minutes	<b>M3460B-L038-240-R9</b>	34.00" x 16.00" x 14.00"
50 kW	170 A	4 Minutes	<b>M3460B-L050-240-R9</b>	34.00" x 16.00" x 14.00"
75 kW	255 A	4 Minutes	<b>M3460B-L075-240-R2</b>	52.00" x 24.00" x 14.00"
100 kW	340 A	4 Minutes	<b>M3460B-L100-240-R2</b>	52.00" x 24.00" x 14.00"
<b>380 - 415 VAC</b>				
43 kW	85 A	4 Minutes	<b>M3460B-E043-240-R10</b>	28.00" x 16.00" x 14.00"
65 kW	127 A	4 Minutes	<b>M3460B-E065-240-R9</b>	34.00" x 16.00" x 14.00"
87 kW	170 A	4 Minutes	<b>M3460B-E087-240-R9</b>	34.00" x 16.00" x 14.00"
130 kW	255 A	4 Minutes	<b>M3460B-E130-240-R2</b>	52.00" x 24.00" x 14.00"
175 kW	340 A	4 Minutes	<b>M3460B-E175-240-R2</b>	52.00" x 24.00" x 14.00"
<b>433 - 480 VAC</b>				
50 kW	85 A	4 Minutes	<b>M3460B-H050-240-R10</b>	28.00" x 16.00" x 14.00"
75 kW	127 A	4 Minutes	<b>M3460B-H075-240-R9</b>	34.00" x 16.00" x 14.00"
100 kW	170 A	4 Minutes	<b>M3460B-H100-240-R9</b>	34.00" x 16.00" x 14.00"
150 kW	255 A	4 Minutes	<b>M3460B-H150-240-R2</b>	52.00" x 24.00" x 14.00"
200 kW	340 A	4 Minutes	<b>M3460B-H200-240-R2</b>	52.00" x 24.00" x 14.00"
<b>575 - 600 VAC</b>				
60 kW	85 A	4 Minutes	M3460B-C060-240-R10	28.00" x 16.00" x 14.00"
90 kW	127 A	4 Minutes	M3460B-C090-240-R9	28.00" x 16.00" x 14.00"
125 kW	170 A	4 Minutes	M3460B-C125-240-R9	34.00" x 16.00" x 14.00"
185 kW	255 A	4 Minutes	M3460B-C185-240-R2	44.00" x 16.00" x 14.00"
245 kW	340 A	4 Minutes	M3460B-C245-240-R2	44.00" x 16.00" x 14.00"



## Undervoltage Solutions

Bonitron M5628 Chargers maintain energy levels in batteries and ultracapacitors. Can also be used as a DC power supply.

Some industrial systems require back-up power to protect critical processes from power outages and voltage sags. Energy storage devices such as batteries and capacitors are required for outage protection. A charger is necessary to keep the energy storage reservoirs at the appropriate levels.



### Rack Mount Version Available



## M5628 Series

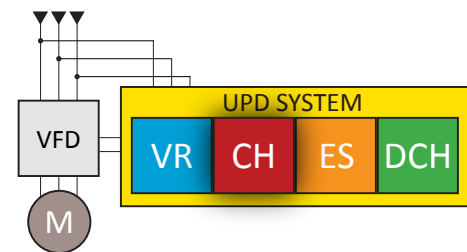

### New Digital Display

- LCD backlit display
- Shows current status of the charger
- Makes records of unit faults
- Allows user to select actions or access other screens

### Product Highlights

- Maintain energy levels in batteries and ultracapacitors
- Adjustable current limit and charge voltage
- Digital Display
- Isolated status contacts

### Model Number Selection

	Max Charge Current	Input Voltage	Model Number	Max Charge Current			Dimensions (H x W x D)
				230-240VAC	380-415VAC	460-480VAC	
	20A	208-506VAC (50-60Hz)	M5628-H020-A6	300VDC	500VDC	600VDC	18.60" x 6.25" x 11.25"
	20A	208-506VAC (50-60Hz)	M5628-H020-A6R	300VDC	500VDC	600VDC	6.94" x 18.88" x 17.09"



## M3528

### Undervoltage Solutions

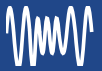

## M3528 Series

Bonitron M3528 Chargers maintain energy levels in batteries and ultracapacitors.

Some industrial systems require back-up power to protect critical processes from power outages and voltage sags. Energy storage devices such as batteries and capacitors are required for outage protection. A charger is necessary to keep the energy storage reservoirs at the appropriate levels.

### Product Highlights

- Maintain energy levels in batteries and ultracapacitors
- Adjustable current limit
- LED indicators
- Isolated status contacts

UL Listed when used with capacitors



### Uninterruptible Power for Drives (UPD)

#### Parallel Connection

- High Reliability
- Seamless power transfer

#### Increased Efficiency

- Ultra low standby power
- Sized to drive systems
- Few AC/DC conversions

*Isolation Transformer required. Contact Bonitron for sizing.*

	Charger					
	Max Charge Current	Input Voltage	Model Number	Charge Voltage	Dimensions (H x W x D)	
208 - 230VAC						
	10A	160-253VAC	<b>M3528AC-L010-A6</b>	175-325VDC	18.60" x 6.25" x 11.25"	
	20A	160-253VAC	<b>M3528AC-L020-K8</b>	175-325VDC	20.00" x 8.20" x 11.10"	
380 - 415VAC						
	10A	277-506VAC	<b>M3528AC-E010-A6</b>	325-600VDC	18.60 x 6.25 x 11.25"	
	20A	277-506VAC	<b>M3528AC-E020-K8</b>	325-600VDC	20.00" x 8.20" x 11.10"	
460 - 480VAC						
	10A	277-506VAC	<b>M3528AC-H010-A6</b>	325-600VDC	18.60" x 6.25" x 11.25"	
	20A	277-506VAC	<b>M3528AC-H020-K8</b>	325-600VDC	20.00" x 8.20" x 11.10"	
575 - 600VAC						
	5A	346-600VAC	M3528AC-C005-A6	406-675VDC	18.60" x 6.25" x 11.25"	





## Undervoltage Solutions



### M3528B Series

The M3528B Battery Energy Storage Modules are designed for simple integration and scalability, and are typically used in conjunction with Bonitron Battery Voltage Regulators and Battery Chargers to provide critical processes with 100% power outage protection or offer "dark start" capabilities. M3528B Battery Modules are offered in 108V and 120V and can be connected in series or parallel to be used with 230 or 460VAC systems.

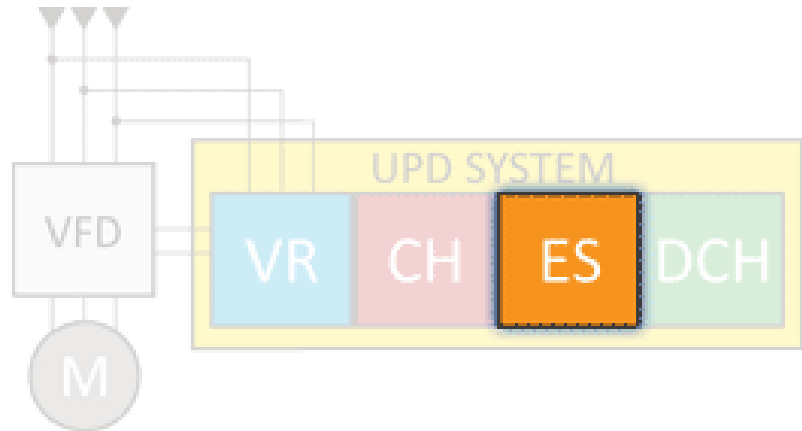

	System Voltage	Model Number	Peak Output Current	Quantity	Enclosure	Dimensions (H x W x D)
	208 VAC	M3528B-108-040-B5	40 A	2	NEMA-1 with Connector	17.60" x 5.10" x 9.40"
	230 VAC	M3528B-120-040-B5				
	400 VAC	M3528B-108-040-B5	40 A	4	NEMA-1 with Connector	17.60" x 5.10" x 9.40"
	460 VAC	M3528B-120-040-B5				

### Industry Applications



Critical Data | Elevators | Extrusion | Fibers | Semiconductor | Solar Power | Textiles | Wind Power | & More!



KIT3628

## KIT3628 Series

**Undervoltage Solutions** 

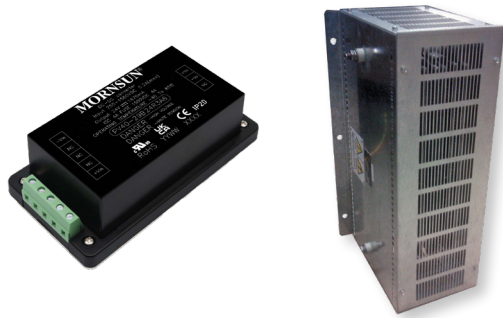

KIT 3628T is a combination of a relay, 24V power supply, and 24V backup module. In conjunction with an appropriately sized M3628R discharge resistor. The system will discharge an attached capacitor bank to below 50V in 1 minute. Automatic discharge can be set up using an aux contact on the cabinet disconnect switch or breaker, or manual discharge can be triggered locally or remotely via PLC control.

KIT 3628T is available in voltages up to 1000 VDC, and in peak currents up to 600 amps. Complementary M3628R resistors are available up to 4000 kJ, and can be paralleled for faster discharge times or for larger energy banks.



### Product Highlights

- Discharge energy in electrolytic and ultracapacitors
- Consists of transistor and resistor
- Ability to abort discharge cycle
- Units may be paralleled for faster discharge

	Charge Voltage (VDC)	Capacitance (Farad)	Energy (kJ)	M3628T Transistor	M3628R Resistor
	400 VDC	4.4 F	350 kJ	KIT 3628T-Y200-V3	M3628R-05.0-0350-6T
		9.4 F	750 kJ		M3628R-03.0-0750-6H
	400 VDC	19 F	1500 kJ	KIT 3628T-Y600-V3	M3628R-00.8-1500-6H
		25 F	2000 kJ		M3628R-00.8-2000-6H
		38 F	3000 kJ		M3628R-00.7-3000-10H
		50 F	4000 kJ		M3628R-00.7-4000-14H
	450 VDC	3.5 F	350 kJ	KIT 3628T-Y200-V3	M3628R-05.0-0350-6T
		7.4 F	750 kJ		M3628R-03.0-0750-6H
	450 VDC	15 F	1500 kJ	KIT 3628T-Y600-V3	M3628R-00.8-1500-6H
		20 F	2000 kJ		M3628R-00.8-2000-6H
		30 F	3000 kJ		M3628R-00.8-3000-10H
		40 F	4000 kJ		M3628R-00.8-4000-14H
	500 VDC	2.8 F	350 kJ	KIT 3628T-Y200-V3	M3628R-03.5-0350-6T
		6.0 F	750 kJ		M3628R-03.5-0750-6H
	500 VDC	12 F	1500 kJ	KIT 3628T-Y600-V3	M3628R-01.0-1500-6H
		16 F	2000 kJ		M3628R-01.0-2000-6H
		24 F	3000 kJ		M3628R-09.0-3000-10H
		32 F	4000 kJ		M3628R-09.0-4000-14H
	550 VDC	2.3 F	350 kJ	KIT 3628T-Y200-V3	M3628R-04.0-0350-6T
		4.9 F	750 kJ		M3628R-04.0-0750-6H
	550 VDC	10 F	1500 kJ	KIT 3628T-Y600-V3	M3628R-01.0-1500-6H
		13 F	2000 kJ		M3628R-01.0-2000-6H
		20 F	3000 kJ		M3628R-01.0-3000-10H
		26 F	4000 kJ		M3628R-01.0-4000-14H
	600 VDC	1.9 F	350 kJ	KIT 3628T-Y200-V3	M3628R-04.0-0350-6T
		4.2 F	750 kJ		M3628R-04.0-0750-6H
	600 VDC	8.3 F	1500 kJ	KIT 3628T-Y600-V3	M3628R-01.0-1500-6H
		11 F	2000 kJ		M3628R-01.0-2000-6H
		17 F	3000 kJ		M3628R-01.0-3000-10H
		22 F	4000 kJ		M3628R-01.0-4000-14H

\*Contact Bonitron for additional voltages and sizes



## Undervoltage Solutions

# KIT 3660DD5

The KIT 3660DD5 is an interactive digital display for the 3460 Series that monitors and stores history of power quality issues, including status, voltage, and current.



Digital Display

	Voltage Regulator			Charger	Model Number
	M3460R Current	M3460B Current	M3534 Current	Use with M3528	
	N/A	N/A	20 A	Yes	KIT 3660DD5-050050C
				No	KIT 3660DD5-050050X
	N/A	N/A	40 A	Yes	KIT 3660DD5-100050C
				No	KIT 3660DD5-100050X
	85 A	85 A	85 A	Yes	KIT 3660DD5-200100C
				No	KIT 3660DD5-200100X
	127 - 170 A	127 - 170 A	N/A	Yes	KIT 3660DD5-400200C
				No	KIT 3660DD5-400200X
	255 - 340 A	255 - 340 A	N/A	Yes	KIT 3660DD5-600400C
				No	KIT 3660DD5-600400X
	425 A	425 A	N/A	Yes	KIT 3660DD5-1K0400C
				No	KIT 3660DD5-1K0400X





## *Input Power Supply & Common Bus Solutions*

### **Common Bus Sharing Diodes**

- M3345CBM

### **Common Bus Isolation Diodes**

- M3460D

### **Regenerative DC Bus Power Supplies**

- M3545P
- M3645P

### **Bus Filter Capacitance**

- M3612EC
- M3612RC

### **3-Phase Power Supplies**

- M3713

### **Single Phase Power Supplies**

- M3712

### **24VDC Power Supplies**

- M7009R
- M7009C





### Why Common DC Bus?

Applications that require multiple motors and drives can be configured to use a Common DC bus. This is being done more often, and with good reasons, including:

- Reduced component count
- Energy savings
- Cost savings

By connecting the DC busses of multiple VFDs, power that is being regenerated by a motor in one part of the system can be consumed by a motor that is powering the system. This is a great advantage for applications with motors that are constantly regenerating while others are motoring. This also allows systems to use one Braking Transistor and Resistor (or Line Regeneration Module) for multiple drives when the line is stopping or decelerating.

Cranes, gantries and other motion systems can also benefit from a common braking solution, as there is typically a single large motor with other smaller motors.

To further reduce component count, a power supply can be used with multiple drives to eliminate multiple power supplies in a drive system.

Any industry application that requires the use of multiple electric motors in a system can benefit from the use of a shared common DC bus. The use of a common bus allows for the reduction of wiring and components, as the linked drives can now share components. It can also allow for the direct sharing of power between drives, reducing amount of power needed from the grid. This can be achieved with either a common bus power supply or with diode sharing.

### Common Bus Power Supply

M3712, M3713

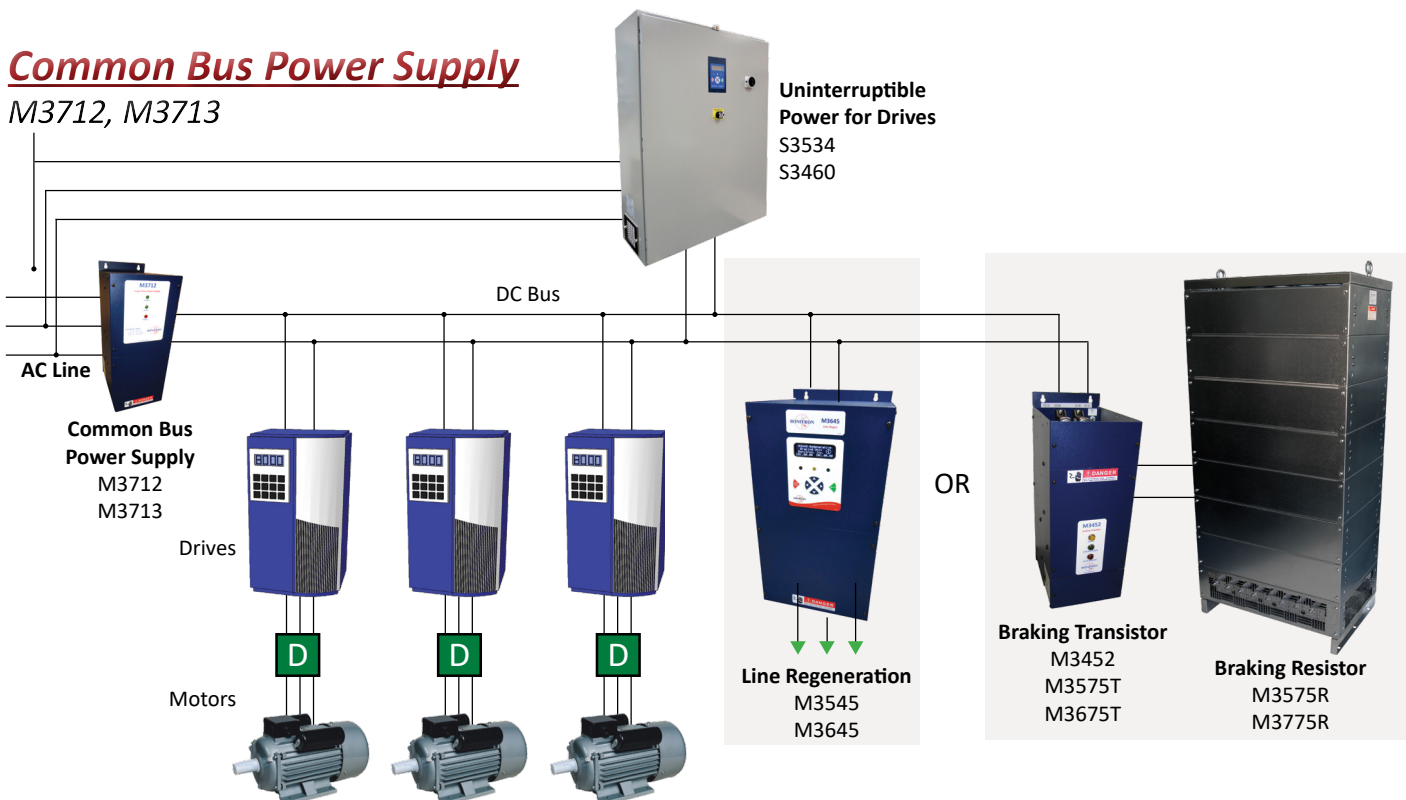



## M3345CBM

### Common Bus Solutions



If drives on the AC line are connected by a DC bus, circulating currents can be created that might cause drive faults. Sharing diodes allow a **two way flow of power** to and from drives, enabling them to share power between their DC busses, while preventing circulating currents. The two-way flow allows the drives to share power with each other or use a common braking, regen, or UPD (Uninterruptible Power for Drives) unit. Multiple drives of similar size can be run through a single diode unit while different size drives can be handled with separate diode units.

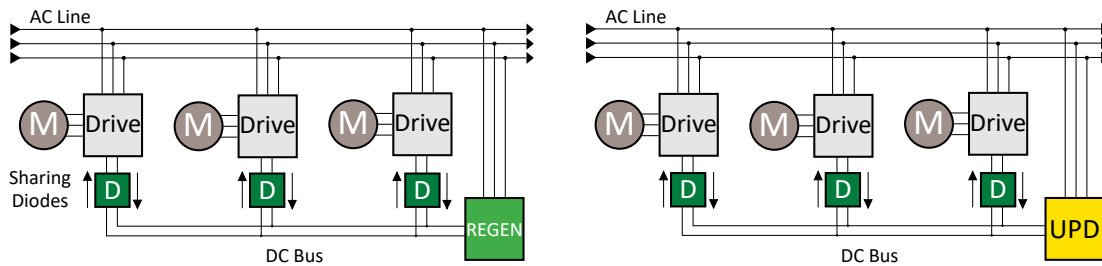

Drive systems are increasingly being configured with a common DC bus and for good reason. Common DC bus configurations create many advantages including cost savings, greater efficiency, and a more versatile system design.

Multiple drives connected through a common DC bus can share a brake or a UPD resulting in reduced component count and reducing cost. Also, if some drives are overhauling while others are motoring, power from the braking drives can be directly shared with the accelerating drives over the DC bus. Bonitron has diodes that allow your drives to share regenerative energy on a common bus (M3345CBM), or share a common UPD (M3460D) while isolating the drives from each other.

Bonitron common DC bus configuration accessories work with drive systems with DC bus connections.

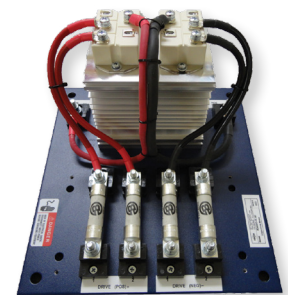

**M3345CBM**  
Series

## M3345CBM

	Nominal HP		Max. # of Drives (per unit)	Model Number	Drive Current	Output Current		Dimensions (H x W x D)
	230-240 VAC	460-480 VAC				Peak	Cont.	
3 HP	5 HP	3	M3345CBM - 10H3	10A	30A	30A	8.50" x 8.50" x 5.50"	
		6	M3345CBM - 10J6		60A		8.50" x 15.00" x 5.50"	
10 HP	20 HP	3	M3345CBM - 30H3	30A	90A	30A	8.50" x 8.50" x 5.50"	
		6	M3345CBM - 30J6		180A		8.50" x 15.00" x 5.50"	
20 HP	40 HP	2	M3345CBM - 60L2	60A	120A	50A	13.00" x 12.00" x 8.00"	
		3	M3345CBM - 60L3		180A			
20 HP	40 HP	4	M3345CBM - 60P4	60A	240A	100A	15.00" x 24.00" x 8.00"	
		6	M3345CBM - 60P6		360A			
30 HP	60 HP	2	M3345CBM - 90N2	90A	180A	100A	14.00" x 15.00" x 8.00"	
		3	M3345CBM - 90N3		270A			
100 HP	200 HP	2	M3345CBM - 200P2	200A	400A	200A	15.00" x 24.00" x 8.00"	
75 HP	150 HP	1	M3345CBM - 200X1	200A	400A	200A	13.75" x 6.90" x 9.25"	
100 HP	200 HP	1	M3345CBM - 250X1	250A	375A	250A	13.75" x 6.90" x 9.25"	
125 HP	250 HP	1	M3345CBM - 300X1	300A	600A	300A	13.75" x 6.90" x 9.25"	
125 HP	250 HP	1	M3345CBM - 350X1	350A	450A	300A	13.75" x 6.90" x 9.25"	





## Input Power Supply Solutions



## M3645P Series

## M3545P Series

The M3645P and M3545P Regenerative DC Bus Power Supply synchronizes to the frequency of the incoming power line, allowing it to automatically adapt to 50Hz or 60Hz input. Under normal conditions, the M3645P rectifies the AC line and supplies power to the load. During a braking event, as the DC bus rises above the AC line peak, the M3645P redirects current from the DC bus into the AC line to limit the rise in bus voltage and prevent over-voltage faults. While regenerating the M3645P will automatically fold back in an overcurrent condition, or shut down in the event that unsafe conditions are detected.



Models with precharge are not UL listed

Up to two 100A M3645P units can be run in parallel for high-power applications.

**Models with precharge will have -R at the end of the model number.**

Phase	Power			Display Type	Model Number	Current		Watt Loss	Dimensions (H x W x D)	Fuse Plate	Required Reactor
	Cont.	Peak	Model Number			Cont.	Peak			Model Number	Model Number
<b>208 - 240VAC</b>											
1	0.9 HP	1.4 HP	LEDs	M3545P-L006-C4	2 A	3 A	34 W	16" x 4.06" x 7.76"	M3545F-H015	N/A	
3	2.8 HP	4.2 HP			6 A	9 A	59 W				
1	2.25 HP	3.5 HP	LEDs	M3545P-L015-M4	5 A	7.5 A	67W	17.00" x 4.70" x 10.80"	M3545F-H015	N/A	
3	7 HP	10.5 HP			15 A	22.5 A	117W				
3	14 HP	21 HP	LEDs+Digital	M3645-L030-M10-D	30 A	45 A	180W	20.00" x 10.00" x 10.10"	M3645F-H030		
3	24 HP	36 HP	LEDs+Digital	M3645P-L050-M11-D	50 A	75 A	265W	22.00" x 11.30" x 10.60"	M3645F-H050		
3	48 HP	72 HP	LEDs+Digital	M3645P-L100-M12-D	100 A	150 A	470W	24.00" x 12.00" x 12.10"	M3645F-H100		
3	72 HP	108 HP	LEDs+Digital	M3645P-L150T-M15-D	150 A	225 A	1000W	26.00" x 13.90" x 11.11"	M3645F-H150	M3645-L150R	
3	108 HP	160.8 HP	LEDs+Digital	M3645P-L225T-M15-D	225 A	335 A	1500W	26.00" x 13.90" x 11.11"	M3645F-H225	M3645-L225R	
3	96 HP	120 HP	LEDs+Digital	M3645P-L300T-M15-D	300 A	375 A	2000W	26.00" x 13.90" x 11.11"	M3645F-H300	M3645-L300R	
<b>380 - 415VAC</b>											
3	25 HP	37 HP	LEDs+Digital	M3645-E030-M10-D	30 A	45 A	180W	20.00" x 10.00" x 10.10"	M3645F-H030		
3	41 HP	62 HP	LEDs+Digital	M3645P-E050-M11-D	50 A	75 A	265W	22.00" x 11.30" x 10.60"	M3645F-H050	N/A	
3	83 HP	125 HP	LEDs+Digital	M3645-E100-M12-D	100 A	150 A	470W	24.00" x 12.00" x 12.10"	M3645F-H100		
3	125 HP	187.5 HP	LEDs+Digital	M3645P-E150T-M15-D	150 A	225 A	1000W	26.00" x 13.90" x 11.11"	M3645F-H225	M3645-E150R	
3	187.5 HP	279.2 HP	LEDs+Digital	M3645P-E225T-M15-D	225 A	335 A	1500W	26.00" x 13.90" x 11.11"	M3645F-H300	M3645-E225R	
3	250 HP	312.5 HP	LEDs+Digital	M3645P-E300T-M15-D	300 A	375 A	2000W	26.00" x 13.90" x 11.11"	M3645F-H300	M3645-E300R	
<b>460 - 480VAC</b>											
1	1.8 HP	2.8 HP	LEDs	M3545P-H006-C4	2 A	3 A	34 W	16" x 4.06" x 7.76"	M3545F-H015	N/A	
3	5.6 HP	8.4 HP			6 A	9 A	59 W				
1	4.5 HP	7 HP	LEDs	M3545P-H015-M4	5 A	7.5 A	67W	17.00" x 4.70" x 10.80"	M3545F-H015	N/A	
3	14 HP	21 HP			15 A	22.5 A	117W				
3	28 HP	43 HP	LEDs+Digital	M3645P-H030-M10-D	30 A	45 A	180W	20.00" x 10.00" x 10.10"	M3645F-H030		
3	48 HP	72 HP	LEDs+Digital	M3645P-H050-M11-D	50 A	75 A	265W	22.00" x 11.30" x 10.60"	M3645F-H050		
3	96 HP	144 HP	LEDs+Digital	M3645P-H100-M12-D	100 A	150 A	470W	24.00" x 12.00" x 12.10"	M3645F-H100		
3	144 HP	216 HP	LEDs+Digital	M3645-H150T-M15-D	150 A	225 A	1000W	26.00" x 13.90" x 11.11"	M3645F-H150	M3645-H150R	
3	216 HP	321.6 HP	LEDs+Digital	M3645P-H225T-M15-D	225 A	335 A	1500W	26.00" x 13.90" x 11.11"	M3645F-H225	M3645-H225R	
3	288 HP	360 HP	LEDs+Digital	M3645-H300T-M15-D	300 A	375 A	2000W	26.00" x 13.90" x 11.11"	M3645F-H300	M3645-H300R	
<b>575 - 600VAC</b>											
3	36 HP	54 HP	LEDs+Digital	M3645-C030-M10-D	30 A	45 A	180W	20.00" x 10.00" x 10.10"	M3645F-C030		
3	60 HP	90 HP	LEDs+Digital	M3645P-C050-M11-D	50 A	75 A	265W	22.00" x 11.30" x 10.60"	M3645F-C050	N/A	
3	120 HP	180 HP	LEDs+Digital	M3645P-C100-M12-D	100 A	150 A	470W	24.00" x 12.00" x 12.10"	M3645F-C100		





### Common DC Bus Filter Capacitance

Extra capacitance (CAP) on the DC Bus with power supply or diode units.

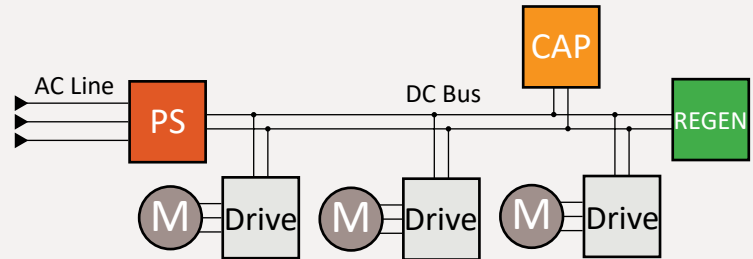

#### 3612EC

- Reduce DC bus ripple from AC conversion

#### 3612RC

- Limit high frequency spikes from switching



## M3612EC Series

The M3612EC is a filter capacitor bank for a common DC bus drive systems. The drives can be either servo or variable frequency drives intended for use with common bus capacitors.

- 7,000 - 28,000µF

	System Voltage	Model Number	Max. Capacitor Voltage	Capacitance	ESR	End-of-Life		Max Ripple Current		Dimensions (H x W x D)
						Capacitance Change	ESR Change	@300Hz 45°C	@300Hz 105°C	
	230-240VAC	M3612EC-L280-K7	450VDC	28,000µF	3.8mΩ	-20%	100%	385A	175A	20.00" x 7.12" x 10.30"
	460-480VAC	M3612EC-H070-K7	900VDC	7,000µF	15.3mΩ	-20%	100%	200A	90A	20.00" x 7.12" x 10.30"

## M3612RC Series

- Limits voltage spikes on Common Bus Systems -

The M3612RC Common Bus Snubber is a high frequency filter that limits spikes and ringing in DC bus systems caused by inverter switching, supply noise, bus reactance, and other sources. Limiting these spikes protects attached drives and power supplies, preventing premature failure.



	Model Number	Capacitor	Resistor	Chassis	Dimension (H x W x D)
460 - 480VAC					
	M3612RC-H12R20C	2000VDC	12 Ohm	M4	12.75" x 4.00" x 9.00"





## Input Power Supply Solutions

Using a common bus power supply reduces the amount of wiring and components in a system, resulting in a reduction of maintenance and footprint of the system. In a system with multiple motors, some motors may be regenerating while others are motoring. The common bus allows the regenerating drives to share power with the motoring drives, thus reducing the amount of power needed from the grid. If the drives are creating a net surplus of energy, a single line regen or braking unit can be installed to dissipate the excess energy.

A common bus power supply can also allow the use of single phase AC power with 3-phase motors without having to oversize the drive. The M3712 can create a common DC bus from single phase power while the M3713 uses 3-phase input power.

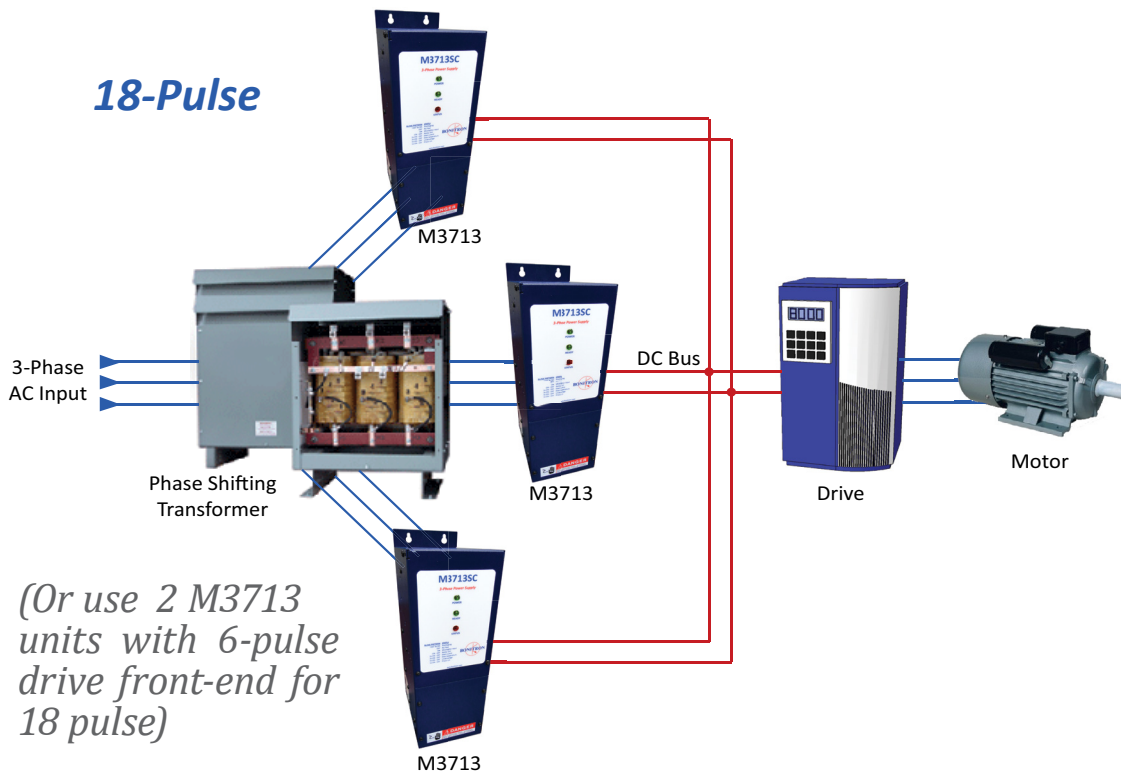

## 12 & 18 Pulse Solutions

Model Number	6-PULSE (One Unit)		12-PULSE (Two Units)		18-PULSE (Three Units)		
	Nominal Drive HP	DC Output Current (Amps)	Nominal Drive HP	DC Output Current (Total Amps)	Nominal Drive HP	DC Output Current (Total Amps)	
<b>230 - 240VAC</b>							
M3713SC-L30-B5	7.5	30	12.5	55	20	80	
M3713SC-L75-B5	20	75	35	135	50	200	
M3713SC-L150-K7	50	150	90	270	135	400	
M3713SC-L225-K7	75	225	135	405	200	600	
M3713SC-L375-K10	125	375	225	675	335	1000	
<b>460 - 480VAC</b>							
M3713SC-H30-B5	15	30	25	55	40	80	
M3713SC-H75-B5	40	75	70	135	100	200	
M3713SC-H150-K7	100	150	180	270	270	400	
M3713SC-H225-K7	150	225	270	405	400	600	
M3713SC-H375-K10	250	375	450	675	675	1000	



## M3712

### Input Power Supply Solutions



The **M3712 Single Phase Power Supply** is a low-cost solution for powering 3-phase AC drives from a single phase source.

3-phase motors are the economical choice for motor applications above 10 horsepower, however many locations only have single phase power available due to the cost of expanding 3-phase availability. Most VFDs are not designed for single phase operation, and even those that are must be oversized by up to 300% when operated from a single phase source.

Fortunately, there is no longer a need to oversize 3-phase drives when using them in single phase applications thanks to the Bonitron M3712 Single Phase Power Supply. The M3712 has a single phase AC input and serves as a power supply for one or multiple drives via DC bus terminal connections. In addition, the M3712 aids in protecting your drive from the high currents caused by single phase operation, which allows your drive to run cooler and longer.



**M3712**  
Series



### Specifications

<b>Overload Limit</b> .....	150% Full Load Rating for 60 seconds
<b>Precharge Ramp Current Limit</b> .....	20% Full Load Rating
<b>Overcurrent Limit</b> .....	200% Full Load Rating
<b>Operating Temp</b> .....	Derate unit 1% per every 1°C above 40°C
<b>Storage Temp</b> .....	-20 to +65 °C
<b>Control I/O</b> .....	Inputs: Enable Outputs: Ready
<b>Indicators</b> .....	Power, Ready, Status

### Product Highlights

- Power one or multiple 3-phase drives from single phase source
- No need to de-rate drive for single phase operation
- Power drives via DC +/- connection
- Added bus capacitance and filtering
- Soft start-up to drives for increased reliability
- UL Listed
- Integrated pre-charge

*Line Reactor Required. Available from Bonitron.*

	Power (Nominal)	Model Number	Output Current	Input Current (AC RMS)	Dimensions (H x W x D)
<b>208 - 240 VAC Drives</b>					
	15 HP	M3712-L015	50 A	87 A	15.00" x 6.20" x 7.30"
	30 HP	<b>M3712-L030</b>	100 A	175 A	20.00" x 7.12" x 10.30"
	50 HP	<b>M3712-L050</b>	160 A	285 A	20.00" x 7.12" x 10.30"
	75 HP	<b>M3712-L075</b>	290 A	550 A	25.00" x 10.00" x 10.20"
	125 HP	<b>M3712-L125</b>	360 A	670 A	32.10" x 14.00" x 12.20"
<b>460 - 480 VAC Drives</b>					
	15 HP	M3712-H015	28 A	58 A	15.00" x 6.20" x 7.30"
	30 HP	<b>M3712-H030</b>	55 A	115 A	20.00" x 7.12" x 10.30"
	50 HP	<b>M3712-H050</b>	90 A	185 A	20.00" x 7.12" x 10.30"
	75 HP	<b>M3712-H075</b>	135 A	250 A	25.00" x 10.00" x 10.20"
	125 HP	<b>M3712-H125</b>	200 A	365 A	32.10" x 14.00" x 12.20"





## Input Power Supply Solutions

The Bonitron M3713 series is a non-regenerative AC to DC rectifier that can serve as the main power supply for your common bus DC system.

Drive systems are more commonly being configured with a common DC bus; for good reason. Common DC bus configurations create advantages including:

- Cost savings
- Greater efficiency
- More versatile system design

One method of creating a common bus systems is the use of a rectifier that supplies DC power to all of the drives instead of individual rectifiers for each drive. The Bonitron M3713 is the ideal solution for this method.

Multiple M3713 Power Supplies can be used in parallel for high power applications, as well as for redundancy and increased process reliability.

The M3713 can also be used as a building block for 12 and 18 pulse systems using standard VFDs. These systems mitigate harmonics and other power quality issues. **Multiple M3713 units used with a phase shifting transformer allows standard drives to meet IEEE 519 compliance.**



## M3713 Series



## Specifications

### M3713SC (with precharge)

### M3713DM (without precharge)

230-240 VAC, 460-480 VAC, 575-600 VAC	<b>Input Voltage</b>	230-240 VAC, 460-480 VAC, 575-600 VAC
150% Full Load Rating for 60 seconds	<b>Intermittent duty Limit</b>	150% Full Load Rating for 60 seconds
20% Full Load Rating	<b>Precharge Ramp Current Limit</b>	N/A
175% Full Load Rating	<b>Overload Limit</b>	N/A
24V+ Sinking Precharge Enable Run Enable	<b>Control Inputs</b>	N/A
250VAC, 120mA Max Precharge Complete Ready	<b>Control Outputs</b>	250VAC @ 120mA 110VAC @ 500mA Overtemp (NC)
Power, Ready, Status	<b>Indicators</b>	Power





## Model Number Selection

Up to 3 units can be in parallel for higher current requirements.

	Power (Nominal)	Precharge	Model Number	Output Current	Dimensions (H x W x D)
<b>208 - 240 VAC</b>					
	7.5 HP	NO	<b>M3713DM-L030-B5</b>	30 A	17.75" x 5.50" x 7.80"
		YES	<b>M3713SC-L030-B5</b>		
	20 HP	NO	<b>M3713DM-L075-B5</b>	75 A	17.75" x 5.50" x 7.80"
		YES	<b>M3713SC-L075-B5</b>		
	50 HP	NO	<b>M3713DM-L150-K7</b>	150 A	20.00" x 7.12" x 10.35"
		YES	<b>M3713SC-L150-K7</b>		
	75 HP	NO	<b>M3713DM-L225-K7</b>	225 A	20.00" x 7.12" x 10.35"
		YES	<b>M3713SC-L225-K7</b>		
	125 HP	NO	<b>M3713DM-L375-K10</b>	375 A	20.00" x 10.00" x 10.50"
		YES	<b>M3713SC-L375-K10</b>		
<b>380 - 415 VAC</b>					
	12 HP	NO	<b>M3713DM-E030-B5</b>	30 A	17.75" x 5.50" x 7.80"
		YES	<b>M3713SC-E030-B5</b>		
	32 HP	NO	<b>M3713DM-E075-B5</b>	75 A	17.75" x 5.50" x 7.80"
		YES	<b>M3713SC-E075-B5</b>		
	80 HP	NO	<b>M3713DM-E150-K7</b>	150 A	20.00" x 7.12" x 10.35"
		YES	<b>M3713SC-E150-K7</b>		
	120 HP	NO	<b>M3713DM-E225-K7</b>	225 A	20.00" x 7.12" x 10.35"
		YES	<b>M3713SC-E225-K7</b>		
	200 HP	NO	<b>M3713DM-E375-K10</b>	375 A	20.00" x 10.00" x 10.50"
		YES	<b>M3713SC-E375-K10</b>		
<b>460 - 480 VAC</b>					
	15 HP	NO	<b>M3713DM-H030-B5</b>	30 A	17.75" x 5.50" x 7.80"
		YES	<b>M3713SC-H030-B5</b>		
	40 HP	NO	<b>M3713DM-H075-B5</b>	75 A	17.75" x 5.50" x 7.80"
		YES	<b>M3713SC-H075-B5</b>		
	100 HP	NO	<b>M3713DM-H150-K7</b>	150 A	20.00" x 7.12" x 10.35"
		YES	<b>M3713SC-H150-K7</b>		
	150 HP	NO	<b>M3713DM-H225-K7</b>	225 A	20.00" x 7.12" x 10.35"
		YES	<b>M3713SC-H225-K7</b>		
	250 HP	NO	<b>M3713DM-H375-K10</b>	375 A	20.00" x 10.00" x 10.50"
		YES	<b>M3713SC-H375-K10</b>		
<b>575 - 600 VAC</b>					





## Input Power Supply Solutions



## M7009R & M7009C

Bonitron's M7009R is a cost-effective solution for protecting your 24-volt DC bus from short-duration sags and outages.

During normal operation, the unit trickle charges from the 24V bus, fully charging in under six minutes, with a peak charge current of 1.5A. Once charged, the unit draws minimal power from the 24V bus.

During an outage, the module supports the 24V bus for a period depending on the power draw.

The M7009R contains no batteries or other parts requiring maintenance. The module is truly plug and-play, requiring only two connections. With the addition of the M7009C extension, you can expect improvements in hold-up time as well as increased outage duration. With the M7009R, you can have confidence that your controls, relays, and other 24V loads will continue to operate during most outages.

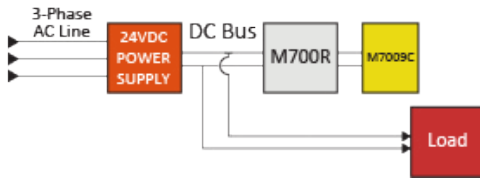

### Buffer Series Highlights

- Charges from DC Bus
- Holds up DC Bus when supply is lost.
- DIN rail mountable

## Hold Up Times

### M7009R

Using Integrated 20F Storage	
Load (A)	Hold-Up Time (s)
20	4
18	5
16	6
14	8
12	10
10	13
8	17
6	23
4	37
2	74

### M7009C

Using Integrated 20F Storage with External 20F Expansion	
Load (A)	Hold-Up Time (s)
20	8
18	11
16	13
14	17
12	21
10	27
8	35
6	49
4	74
2	150

Model Number	Standby Voltage	Hold-Up Voltage	Rated Output	Power	Internal Storage Capacitance	Internal Storage Energy	Dimensions (HxWxD)
M7009R - 24V20A - DIN	23.25 - 27 VDC	23.25 - 23.75 VDC	20A	480W	20 F	5760 J	5.375"x5"x5.75"
M7009C - 24V - DIN	23.25 - 27 VDC	-	-	-	20F	5760 J	5.375"x3.1"x5.75"





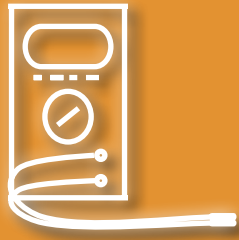

## *Maintenance Solutions*

### **Portable Ultracapacitor Former**

- M3628PCF

### **Automatic Capacitor Former**

- M3628ACF

### **Portable Ultracapacitor Discharger**

- M3628PUD

### **Portable Ultracapacitor Tester**

- M3628UCT

### **Ultracapacitor Module Tester**

- M3628UMT

### **Regen Energy Monitor**

- M3660REM





## Maintenance Solutions

### Why Bonitron Maintenance Solutions?

Bonitron offers maintenance solutions that allow you to charge, discharge, form, and test energy storage.

Test your capacitors to see when they are approaching their "end of life" and replace them before an unnecessary and expensive failure occurs. If you have capacitors that have been stored for a while, reform them with our M3628PCF Portable Capacitor Former to avoid damage to your drive at start up.

A great benefit of many of Bonitron's Maintenance Solutions is portability - making testing and maintenance more convenient!

### Portable Capacitor Former

#### M3628PCF

When variable frequency drives are stored for long periods (typically over eight months), the internal chemistry of their capacitors may begin to deteriorate and need to be reformed prior to use. If the capacitors are not reformed before the drive is put into use, the capacitors have the potential to fail which can cause extensive damage to the drive.

#### Product Highlights

- Charges, discharges, and forms capacitors
- Manually variable output voltage: 0 - 900 VDC
- Digital voltage and current displays
- Overcurrent and over temperature protection
- Tough impact and weather resistant case



#### M3628PCF

#### M3628PCF Selection

Model Number	Input Voltage	Max Output Voltage	Max Output Current	Max Load Capacitance	Weight
M3628PCF-Y01-110	110 - 120 VAC	1100 VDC	1 ADC	100000 uF	65 LBS
M3628PCF-Y01-220	220 - 240 VAC				



## M3628ACF & M3628PUT

Maintenance Solutions



### M3628ACF

As electrolytic capacitors' age approach end-of-life, their capacitance drops significantly below their original specification. These capacitors typically need replacement to avoid process failure. Measuring the actual capacitance helps determine when these capacitors reach EOL (end of life), avoiding both process failure and expensive, unnecessary preemptive replacement.

#### Product Highlights

- Charges, discharges, measures, and forms capacitors
- Variable output voltage: 0 - 1000 VDC
- Digital LCD display
- Portable - case on wheels
- Operates from standard 120 VAC supply

#### M3628ACF Selection

	Model Number	Input Voltage	Output Voltage	Output Current	Max. Capacitance
	M3628ACF-Y01-120	120VAC	1000 VDC	0-1 ADC	300,000 uF
	M3628ACF-Y01-240	240VAC	1000 VDC	0-1 ADC	300,000 uF



### M3628PUD

The M3628PUD ultracapacitor discharger is designed to deplete energy stored in ultracapacitor modules. It is capable of fully discharging the modules every 5 minutes. It includes a DC contactor for switching the resistor, a voltmeter for displaying the remaining voltage left on the module, 120VAC and 240VAC power cables, and 6 foot cables for connecting the module to the discharger.

#### Product Highlights

- Powered by standard 120VAC and 240VAC
- LED display to view remaining voltage
- Allows quick discharging of modules
- Tough impact and weather resistant case

#### M3628PUD Selection

Model Number	Capacitor Module			Resistor			Dimensions	Weight
	Voltage	Farads	Joules	Resistance	Peak Power	RMS Power		
M3628PUD-016-058	16 VDC	58 F	7.5 kJ	0.5 Ohms	500 W	100 W	6.0"H x 13.4"W x 11.7"D	9 lbs
M3628PUD-016-500	16 VDC	500 F	65 kJ	0.09 Ohms	2800 W	500 W	6.9"H x 16.5"W x 13.0"D	19 lbs
M3628PUD-048-166	48 VDC	166 F	190 kJ	0.16 Ohms	14.4 KW	1200 W	9.0"H x 22.0"W x 13.9"D	32 lbs
M3628PUD-160-006	160 VDC	6 F	75 kJ	5 Ohms	5000 W	400 W	6.9"H x 16.5"W x 13.0"D	16 lbs
M3628PUD-096-083	96 VDC	83 F	380 kJ	1.2 Ohms	7.7 KW	1200 W	22.0"H x 13.8"W x 9.0"D	32 lbs





## Maintenance Solutions



### M3628UCT

The M3628UCT ultracapacitor tester is designed to determine the capacitance and ESR of cells and modules up to 20V. A full test cycle delivers an adjustable constant current to charge the test capacitor to a desired voltage, holds the test voltage, then discharges at a constant current. It can also be operated solely as a voltage source or current source/sink.

#### Product Highlights

- Charges, discharges, measures ultracapacitors
- Variable output voltage: 2 - 20 V
- Digital control interface
- Operates from standard 90 - 264 VAC supply
- Tough impact and weather resistant case

#### M3628UCT Selection

	Model Number	Input Voltage	Input Frequency	Max Output Voltage	Max Charging Current	Max Load Capacitance
	M3628UCT-D30-120	90 - 132 VAC	47-63Hz	20 V	30 A	6500 F
	M3628UCT-D30-240	180 - 264 VAC				

## Portable Ultracapacitor Module Tester

### M3628UMT

The M3628UMT ultracapacitor tester is designed to determine the capacitance and ESR of modules up to 170V. A full test cycle delivers an adjustable constant current to charge the test capacitor to a desired voltage, holds the test voltage, then discharges at a constant current. It can also be operated solely as a voltage source or current source/sink.

#### Product Highlights

- Charges, discharges, measures ultracapacitor modules
- Variable output voltage: 10 - 170 V
- Digital control interface
- Operates from standard 90 - 260 VAC supply
- Tough impact and weather resistant case



### M3628UMT

#### M3628UMT Selection

	Model Number	Input Voltage	Input Frequency	Max Output Voltage	Max Charging Current	Max Load Capacitance
	M3628UMT-U07-120	90 - 130VAC	47-63Hz	170 V	7 A	2000 F
	M3628UMT-U07-240	180 - 260 VAC				





When variable speed drive systems are braking, they generate power that must be dissipated. If the excess energy is not dissipated, the drive system can lose control of the process due to an overvoltage trip, or must extend the braking time to keep from overpowering the drive. The traditional method of dissipating excess energy is burning the energy off in a resistor, but resistors take up significant amounts of space and generate an abundance of heat.

The M3660REM Regenerative Energy Monitor is designed to monitor the voltage and current of the resistor to calculate the total energy dissipated across the resistor. The resulting data can be used to size a Bonitron Line Regen to replace the resistor and minimize heat loss, shrink footprint, and return the energy to the AC line.



### Simple Connection

1. Hook the REM up to the resistor connections, clamp current clamp around one lead.
2. Run the drive thru cycle for each type of varying lead.

### Product Highlights

Will record for each braking event:

- Total length
- Peak current
- Total energy(in joules)
- Peak power

### M3660REM Selection

Model Number	Drive AC Voltage	Max Monitoring Voltage	Max Monitoring Current	Weight
M3660REM-C2000-B	230 - 600 VAC	1000 VDC	2000 ADC	10 LBS



# Industry Solutions

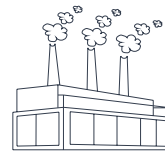

**Agriculture**



**Boilers**



**Centrifuges**



**Common DC Bus**



**Cranes & Hoists**



**HVAC**



**Logging & Sawmill**



**Marine**

## Additional Industries...

No matter what industry your AC drive and motor support, Bonitron has the solution to enhance your process and increase uptime.

While our industry brochures above reflect completed app notes, the items below are a sampling of additional industries Bonitron serves. Feel free to contact us to discuss your application as we continue to build application notes for additional processes and industries.

- Automotive
- Chemical Processing
- Critical Data
- Entertainment/ Stages
- Fiber
- Food Processing
- Metals
- Mining
- Packaging
- Paper
- Petrochemical
- Pharmaceutical
- Recycling
- Semiconductor
- Security
- Textiles
- Transportation
- Water/ Wastewater
- + Many more!



**Material Handling**



**Oil & Gas**



DOWNLOAD INSTRUCTION MANUALS AT

# BONITRON.COM/SUPPORT



BONITRON.COM/SUPPORT

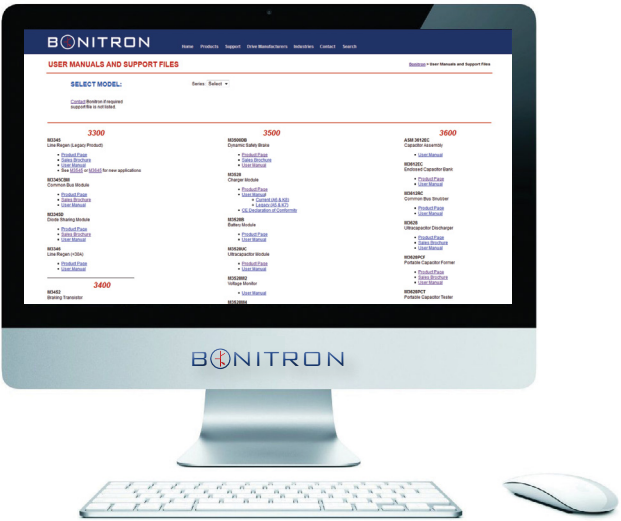

## PRODUCT SUPPORT

*Please provide the following when contacting Bonitron:*

- Full Model Number
- Drive Power
- Serial Number
- Application



www.bonitron.com



615-244-2825

info@bonitron.com



## Motor Application Formula

### Calculating Horsepower

Once the machine torque requirement is determined, horsepower can be calculated using the formula:

$$HP = \frac{T \times N}{5,250}$$

Where,

HP = Horsepower

T = Torque (ft-lb)

N = Base speed of motor (rpm)

If the calculated horsepower falls between standard available motor ratings, select the higher available horsepower rating. It is good practice to allow some margin when selecting the motor horsepower.

for many applications, it is possible to calculate the horsepower required without actually measuring the torque required. The following useful formulae will help:

### Conveyors

$$HP \text{ (Vertical)} = \frac{\text{Weight (lb)} \times \text{Velocity (FPM)}}{33,000}$$

$$HP \text{ (Horizontal)} = \frac{\text{Weight (lb)} \times \text{Velocity (FPM)} \times \text{Coefficient of Friction}}{33,000}$$

### Web Transport Systems and Surface Winders

$$HP = \frac{\text{Tension (lb)} \times \text{Velocity (FPM)}}{33,000}$$

Note: The tension value used in this calculation is the actual web tension for surface winder applications. For sectional drives, it is the tension differential: downstream tension - upstream tension.

### Center Winders (Control to Base Speed Only)

$$HP = \frac{\text{Tension (lb)} \times \text{Line Speed (FPM)} \times \text{Buildup}}{33,000 \times \text{Taper}}$$

### Center Winders (Field Control)

If Taper x Field Range  $\geq$  Buildup, then,

$$HP = \frac{\text{Tension (lb)} \times \text{Line Speed (FPM)}}{33,000}$$

If Taper x Field Range  $\leq$  Buildup, then,

$$HP = \frac{\text{Tension (lb)} \times \text{Line Speed (FPM)} \times \text{Buildup}}{33,000 \times \text{Taper} \times \text{Field Range}}$$

Note: The preceding formulas for calculating horsepower do not include any allowance for machine function windage or other factors. These factors must be considered when selecting a drive for a machine application.

### Fans and Blowers

$$HP = \frac{\text{CFM} \times \text{Pressure (lb/ft}^2\text{)}}{33,000 \times \text{Efficiency of Fan}}$$

Effect of Speed on HP:

HP =  $K_1(\text{RPM})^3$  — Horsepower varies as the 3<sup>rd</sup> power of power of speed.

T =  $K_2(\text{RPM})^2$  — Torque varies as the 2<sup>nd</sup> power of speed.

Flow =  $K_3(\text{RPM})$  — Flow varies directly as the speed.

$$HP = \frac{\text{CFM} \times \text{Pressure (lb/in}^2\text{)}}{229 \times \text{Efficiency of Fan}}$$

$$HP = \frac{\text{CFM} \times \text{Inches of Water Gauge}}{6356 \times \text{Efficiency of Fan}}$$

### Pumps

$$HP = \frac{\text{GPM} \times \text{Head (ft)} \times \text{Specific Gravity}}{3960 \times \% \text{ Efficiency of Pump}}$$

Specific Gravity of Water = 1.0

1ft<sup>3</sup> per sec. = 448 GPM

1 PSI = A head of 2.309 ft for water weighing 62.36 lb/ft<sup>3</sup> at 62°F

### Constant Displacement Pumps

Effect of speed on HP:

HP = K (RPM) — Horsepower and capacity vary directly as the speed.

Displacement pumps under constant head require approximately constant torque at all speeds.

### Constant Displacement Pumps

Effect of Speed on HP:

HP =  $K_1(\text{RPM})^3$  — Horsepower varies as the 3<sup>rd</sup> power of power of speed.

T =  $K_2(\text{RPM})^2$  — Torque varies as the 2<sup>nd</sup> power of speed.

Flow =  $K_3(\text{RPM})$  — Flow varies directly as the speed.

Efficiency:

500 to 1,000 gal/min	= 70% to 75%
1,000 to 1,500 gal/min	= 75% to 80%
Larger than 1,500 gal/min	= 80% to 85%

Displacement pumps may vary between 50% and 80% efficiency, depending on size of pumps.





# Electric Formulas

## Ohms Law

$$\text{Amperes} = \frac{\text{Volts}}{\text{Ohms}} \quad \text{or} \quad \text{Ohms} = \frac{\text{Volts}}{\text{Amperes}}$$

$$\text{or} \quad \text{Volts} = \text{Amperes} \times \text{Ohms}$$

## Power in DC Circuits

$$\text{Horsepower} = \frac{\text{Volts} \times \text{Amperes}}{746}$$

$$\text{Watts} = \text{Volts} \times \text{Amperes}$$

$$\text{Kilowatts} = \frac{\text{Volts} \times \text{Amperes}}{1,000}$$

$$\text{Kilowatts - Hours} = \frac{\text{Volts} \times \text{Amperes} \times \text{Hours}}{1,000}$$

## Power in AC Circuits

Kilovolt-Amperes (KVA):

$$\text{KVA (1}\phi\text{)} = \frac{\text{Volts} \times \text{Amperes}}{1,000}$$

$$\text{KVA (3}\phi\text{)} = \frac{\text{Volts} \times \text{Amperes} \times \text{Power factor} \times 1.73}{1,000}$$

## Kilowatts (KW)

$$\text{KVA (1}\phi\text{)} =$$

$$\text{KVA (3}\phi\text{)} = \frac{\text{Volts} \times \text{Amperes} \times \text{Power factor} \times 1.73}{1,000}$$

$$\text{Power Factor} = \frac{\text{Kilowatts}}{\text{Kilovolts} \times \text{amperes}}$$

## Kilovolt Amperes:

Single Phase

$$\text{KVA} = \frac{E \times I}{1,000}$$

Two Phase - \*(4 - wire)

$$\text{KVA} = \frac{2 \times E \times I}{1,000}$$

Three Phase

$$\text{KVA} = \frac{1.73 \times E \times I}{1,000}$$

## Horsepower Output:

Single Phase

$$\text{HP} = \frac{E \times I \times \text{Eff} \times \text{PF}}{746}$$

Two Phase - \*(4 - wire)

$$\text{HP} = \frac{2 \times E \times I}{746}$$

Three Phase

$$\text{HP} = \frac{1.73 \times E \times I \times \text{Eff} \times \text{PF}}{746}$$



# NOTES

---

---

---

---

---

---

---

---

---

---

---

---

---

---

---

---

---

---

---

---

---

---

---

---

---

---

---

---

---





## Contact Us

Bonitron has developed thousands of products since 1962. With an educated and experienced Engineering Team, Bonitron is able to work with customers on both standard and custom applications and projects.

If you don't see what you need, call us and we'll work together to create a solution to fit your needs!



FOUNDED 1962

### WWW.BONITRON.COM

- Model Selection Tables
- Sales Brochures
- User Manuals and Drawings
- Industry Applications
- Application Notes
- + More!

### INFO@BONITRON.COM

- Sizing and Technical Support
- Customer Service
- Purchase Orders

### 615-244-2825

- Sizing and Technical Support
- Customer Service

141021 20180810